

JTS[®]



CS-1CH
Chairman Unit



CS-1DU
Delegate Unit

CS-1

i-Conference Discussion System

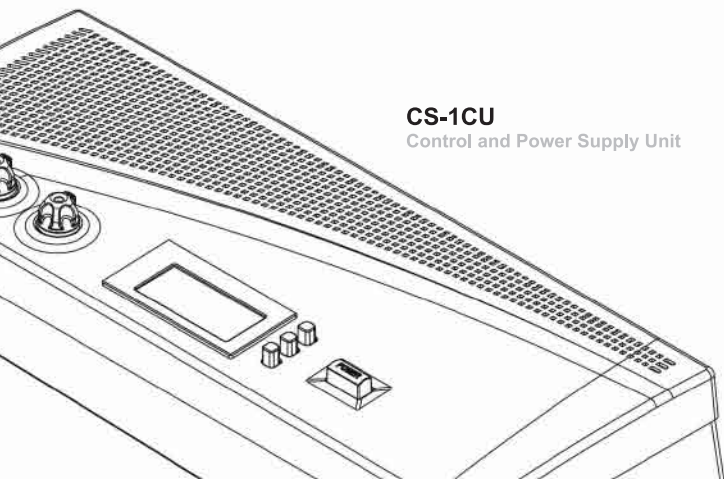

CS-1CU
Control and Power Supply Unit



1. Important Cautions 1

2. Features 1

3. Specification

3.1 Control and power supply unit (CU) 2

3.2 Delegate and Chairman unit 4

4. Preparing Procedure

4.1 Connecting between the delegate and chairman units 6

4.2 Connecting up to 150 unit 6

4.3 Connecting an external microphone 7

4.4 Connecting a wireless microphone 7

4.5 Recording | Playing back the discussion 8

4.6 Connecting a PA-system | other external equipment 8

4.7 Connecting a telephone coupler 9

4.8 Connecting Equalizer or other effects 9

4.9 Connecting power cord 10

5. Operation

5.1 System testing 11

5.2 Date / time setting 11

5.3 Key Lock 11

5.4 Counter operation 12

5.5 Delegate unit operation 12

5.6 Chairman unit operation 13

5.7 Volume control of the delegate and chairman units 13

5.8 Volume control of headphone and internal speaker of CU 14

5.9 Using a headphone 14

5.10 Open mode 15

5.11 Time mode 15

5.12 Override mode 16

5.13 Chairman only mode 16

6. Technical Data

6.1 Electrical and Electro-Acoustical Characteristics 17

6.2 Mechanical Specifications 18

6.3 General Specifications 18

6.4 Pin configuration 19

1. Important Cautions

- Make all connections before plugging the unit into an AC power outlet.
- Do not leave the devices in a place with high temperature or high humidity.
- Do not handle the power cord with wet hands.
- Keep the devices away from fire and heat sources.

2. Features

The innovative CS-1 i-Conference Discussion System is equipped with JTS in-house made ECM capsule, intelligent automatic mixing technology and integrated acoustic and mechanical design, providing Turn-Key solution and delivering consistently natural, feedback-free audio performance with any environment. The i-Conference Discussion System is ideal for discussion and meeting with up-to 150 attendants.

A CS-1 i-Conference Discussion System consists of:

- One Control and power supply unit (CU)
- Maximum 50 delegate or chairman units
- Peripheral audio and/or telecommunication equipment.

The CU is the center of the discussion system which controls the microphones of the chairman and delegate units as well as connects to other audio input and output. It also supplies the power for the CU itself, and up to 50 chairman and delegate units.

The delegate unit enables the attendants to participate in a discussion by speaking through a microphone, controlled by a microphone ON/OFF push-button, and listening discussion by the internal loudspeaker and external headphone.

The chairman unit not only provides the same function as the delegate unit, but also supports the addition of a "Priority button", that enables the chairman to control the discussion by temporary or permanently overriding and deactivating all active microphones of the delegate units.

3. Specification

3.1 Control and power supply unit (CU)

3.1.1 Front Panel

- 1) Power On/Off switch
- 2) LCD display: setting and displaying mode status, simultaneously maximum user number, and date.
- 3) Set button: pressing “set” button to enter setting mode on the LCD panel.
- 4) Up & Down buttons: pressing “Up” or “Down” to switch the setting.
- 5) Speaker Volume control: controlling all connected chairman and delegate units.
- 6) Monitor Volume control: controlling both speaker and headphone of the CU.
- 7) Headphone input: allowing another alternative of listening discussion. While inserting the headphone, the loudspeaker will be deactivated.
- 8) Loudspeaker.

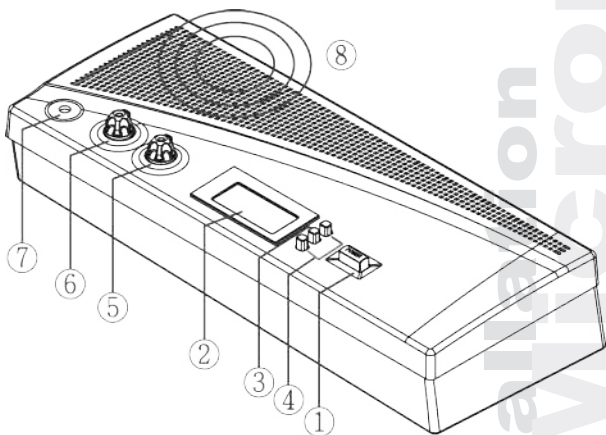

3.1.2 Rear Panel

- 1) DCV input:
- 2) Insertion input and output switch: default setting is “In”, when switching to “In”, all internal speaker will be muted, and switch to external audio device.
- 3) Telephone coupler input and output:
- 4) Insertion input and output: connect to an external audio equalizer for speech quality improvement.
- 5) Recorder input and output: connect to a recorder that could record and play back the discussion.
- 6) Line input and output: connect to PA-System or other audio devices.
- 7) Gain control 1: control the volume level of Recording input.
- 8) Gain control 2: control the volume level of Microphone XLR input.
- 9) Trunk output 1 and 2: connect to chairman and delegate units.
- 10) Microphone XLR input: connect to external microphone or wireless microphone receiver.

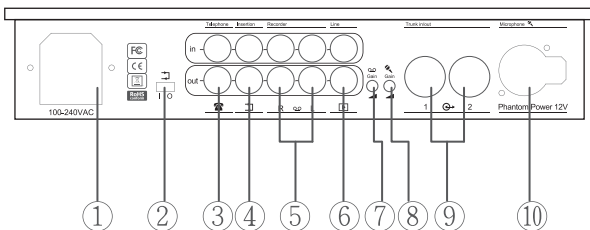

3.1.3 LCD Display

- 1) Mode status: show the discussion mode
- 2) Simultaneously user number: the maximum number of simultaneously active users is four.
- 3) Date | Set: While setting, "Set" will flash.
- 4) Time:

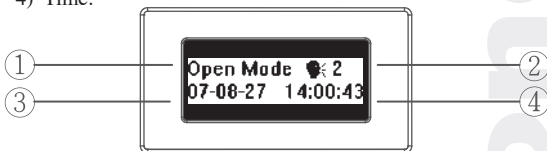

3.2 Delegate and Chairman unit

- 1) Gooseneck Microphone
- 2) Two 3.5mm stereo headphone sockets
- 3) Rotary volume control: control the volume level of the headphone.
- 4) Ring & Microphone "On" indicator: While microphone is activated, both indicators will light up.
- 5) Loudspeaker
- 6) 7-pole circular female socket
- 7) 7 pole circular male connection cable
- 8) Microphone ON/OFF push-button
- 9) Chairman Priority button
- 10) Priority button setting switch: The default setting is "A", meaning when releasing the priority button, the microphone on delegate units will be re-activated. When switching to "B", the microphone on delegate units won't be re-activated after the priority button is released.
- 11) Gooseneck Microphone Gain Control: Control the volume of the microphones on the chairman and delegate units.

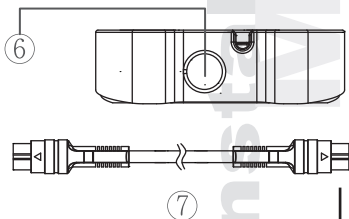
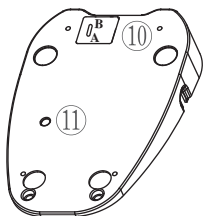

Delegate

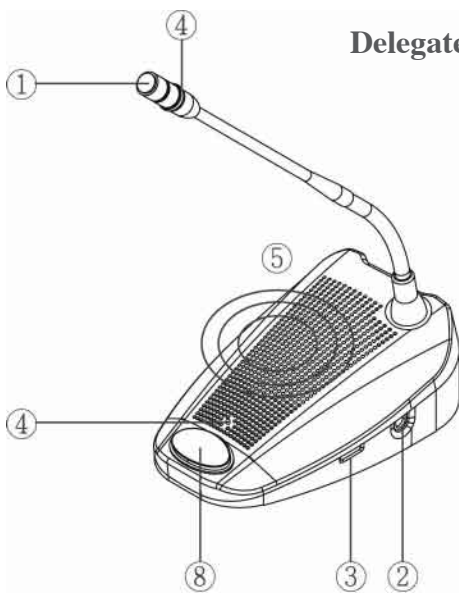

Chairman unit

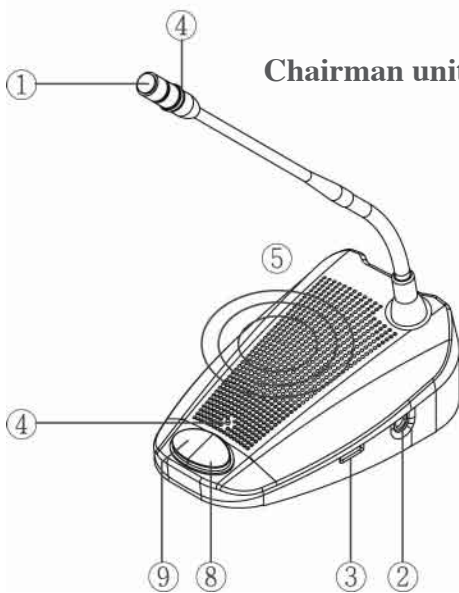

4. Preparing Procedure

4.1 Connecting between the delegate and chairman units

- 1) Insert 7-pole circular male connection cable of the chairman or delegate units into the Trunk socket on the CU.
- 2) Connect the second unit to 7-pole circular female socket of the first unit.
- 3) Repeat the above actions for the rest of units. (Maximum connected number per trunk socket is 25)

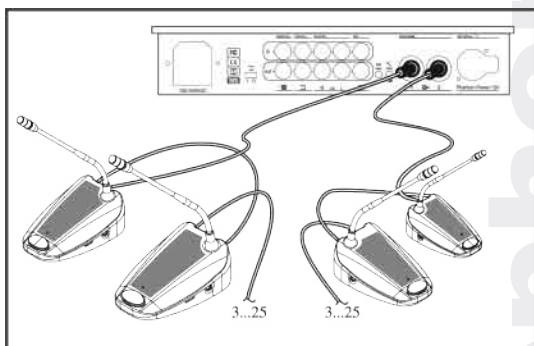

4.2 Connecting up to 150 units

The i-Conference discussion system can be used with up to 150 units by adding maximum 2 additional CUs functioning as power supply units only. The system is controlled by the master CS-1 CU. The cables necessary for these connections can be delivered by your local dealer.

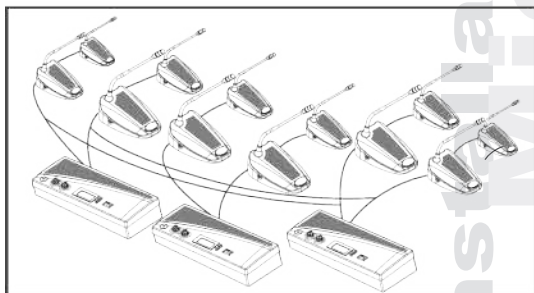

4.3 Connecting an external microphone

- 1) Put the external microphone connector into the microphone XLR input of the CU.
- 2) Adjust the sensitivity by using the gain control 2.

Caution:

Always use the microphone with balanced output.

The microphone XLR input provides a 12V phantom power supply.

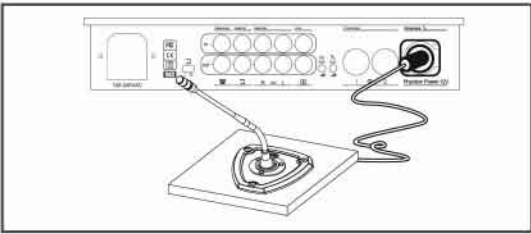

4.4 Connecting a wireless microphone

- 1) Connect a wireless receiver to the microphone XLR input of CU.
- 2) Adjust the sensitivity by using the gain control 1

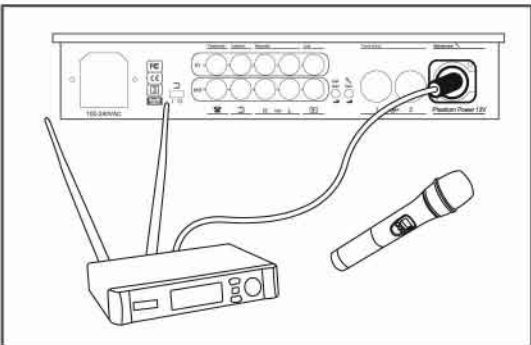

4.5 Recording | Playing back the discussion

Voltage:

- 1) Connect a recorder to the recorder input and output by two pairs of RCA cable.
- 2) Adjust the sensitivity by using the gain control 1

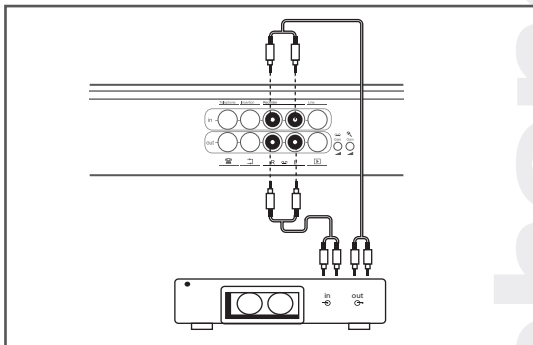

4.6 Connecting a PA-system | other external equipment

- 1) Connect audio sources to the line input by a RCA cable.
- 2) Connect a PA-system or other devices to the line output by a RCA cable.

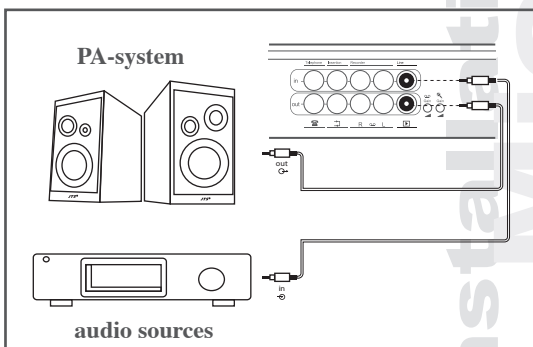

4.7 Connecting a telephone coupler

- 1) Connect the telephone coupler to the telephone input and output of the CU by a pair of RCA cable.
- 2) The telephone coupler would further connect to the telephone wall socket and a telephone.

Caution:

Never try to connect a telephone directly to CS-1 i-Conference Discussion system.

A telephone coupler could provide adequate isolation between the telephone network and the CS-1 i-Conference Discussion System.

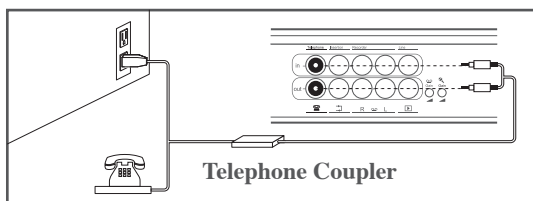

4.8 Connecting Equalizer or other effects

- 1) Connect an equalizer or other effects to the insertion input and output by one pairs of RCA cable.
- 2) When insertion input and output switches to "O/out, audio signal will be processed by effect equalizers that connected to insertion output and input.

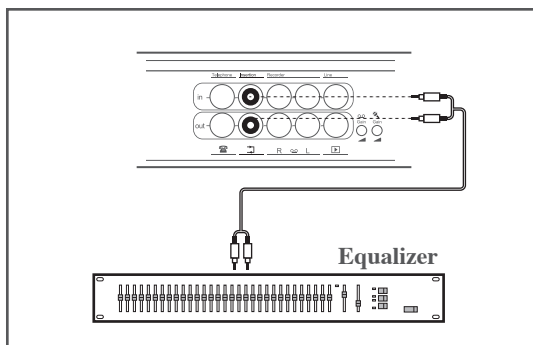

4.9 Connecting power cord

- 1) Using the supplied power cord set to connect the CU to the power supply socket.
- 2) Press Power ON/OFF switch to turn on the system. As soon as the power is on, the LCD Display will light up.

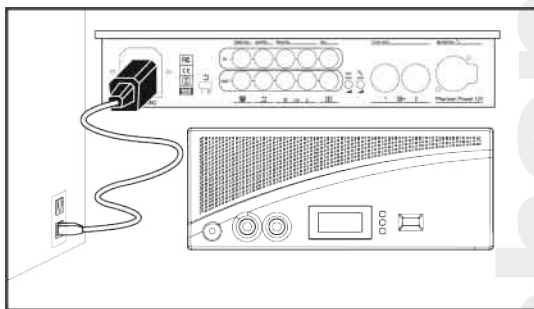

5. Operation

5.1 System testing

- 1) Pressing the “Set” button over 1.5 seconds, the Date | Set area on the LCD Display will flash and show “Set”.
- 2) Press “Up” or “Down” button to choose “System Test” on the Mode Status area of the LCD Display.
- 3) All connected chairman and delegate units will light up.

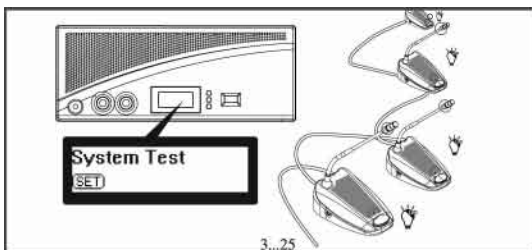

5.2 Date | Time Setting

- 1) Pressing the “Set” button over 1.5 seconds, the Date | Set area on the LCD Display will flash and show “Set”.
- 2) Press “Up” or “Down” button to choose “Set Date/Time” on the Mode Status area of the LCD Display.
- 3) Press “Set”, The “Year” will flash, press “Up” or “Down” button to select.
- 4) Repeat the action 3) to set up “Month”, “Date”, “Hour”, and “Minute”.
- 5) Press the “Set” button to save the settings.

5.3 Key Lock

- 1) Pressing the “Set” button over 1.5 seconds, the Date | Set area on the LCD Display will flash and show “Set”.
- 2) Press “Up” or “Down” button to choose “KeyLock” on the Mode Status area of the LCD Display.
- 3) All buttons will be deactivated.
- 4) Repeat above action again to unlock..



5.4 Counter Operation

- 1) Pressing the "Set" button, the Date | Set area on the LED Display will show "Counter"



- 2) Pressing "Up" to start counting.



- 3) Pressing "Up" again to stop.



- 4) Pressing "Down" to clear data after stopping.
- 5) Pressing the "Set" button again to jump back the original display. Notice that you can operate any other functions of the control unit when the counter is used.

5.5 Delegate unit operation

- 1) Depending on the setting of the microphone mode on the CU, pressing the microphone ON/OFF push-button will activate the gooseneck microphone.
- 2) Pressing again turns the microphone off



5.6 Chairman unit operation

- 1) Independent of the setting of the microphone mode on the CU, pressing the microphone ON/OFF” push-button will activate the gooseneck microphone on the chairman unit.
- 2) Pressing again turns the microphone off.
- 3) Pressing and holding the chairman priority button will deactivate all active delegate units and activate the chairman microphone.
- 4) Releasing the button will activate them again.

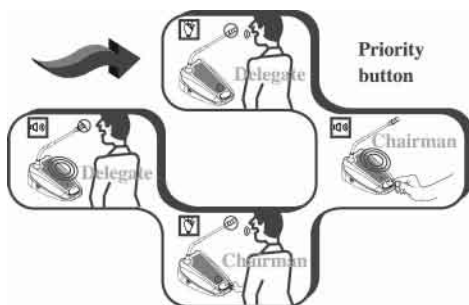

5.7 Volume control of the delegate and chairman units

- 1) Turning the speaker volume control to adjust the volume of the loudspeakers of the delegate and chairman units.
- 2) In the fully counterclockwise position, all loudspeakers will be muted.

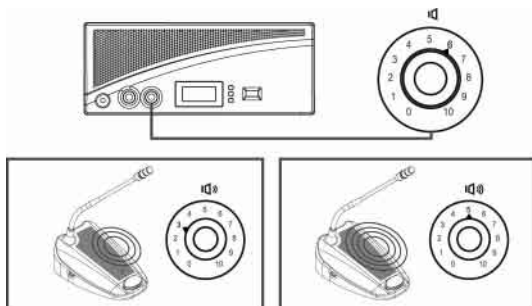

5.8 Volume control of headphone and internal speaker of CU

- 1) While using internal speaker or headphone to monitor the discussion, turning the monitor volume control to adjust the volume of them.
- 2) The maximum volume level is controlled by the speaker volume control of CU

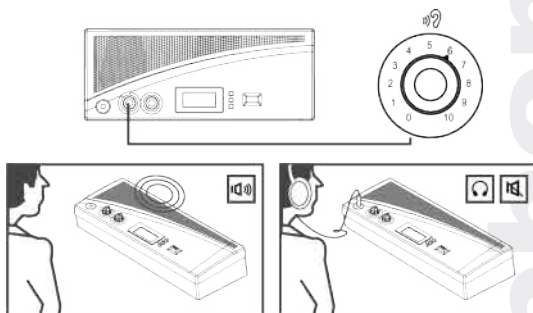

5.9 Using a headphone

- 1) Connecting the headphones to the left and/or right side of the units.
- 2) Inserting a headphone jack will mute the loudspeaker.
- 3) Adjusting the volume of the headphones by using the rotary volume control.
- 4) The maximum volume level depends on the level of the speaker volume control on the CU.

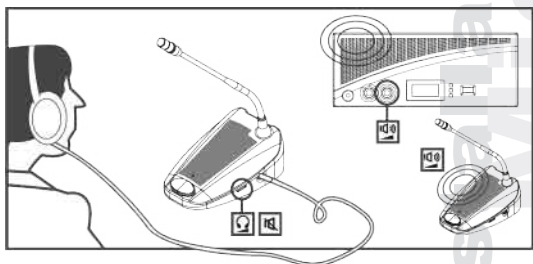

5.10 Open mode

- 1) Pressing the “Set” button over 1.5 seconds, the Date | Set area on the LCD Display will flash and show “Set”.
- 2) Press “Up” or “Down” button to choose “Open Mode” on the Mode Status area of the LCD Display.
- 3) Press “Set” button again, the number on simultaneously user number will flash.
- 4) Press “Up” or “Down” button to choose the simultaneously user number (1,2,3,4).
- 5) Press “Set” button to save the changes.

Under “Open mode”, press the microphone ON/OFF push-button on chairman and delegate units will activate the microphone. Press again will deactivate it.

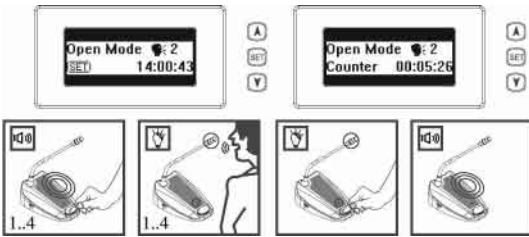

5.11 Time mode

- 1) Selecting the “Time mode” and simultaneously maximum user number as the 5.10 procedures.

Under “Time mode”, press the microphone ON/OFF push-button on delegate units will activate the microphone for 30 seconds. If the number of active delegate units is smaller than the maximum user number, press again will activate it for another 30 seconds.

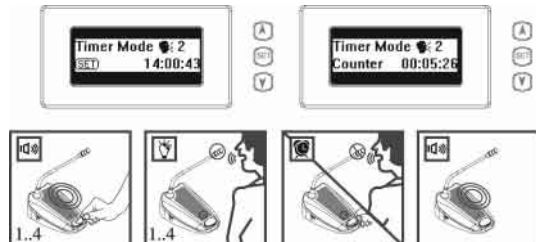

5.12 Override mode

1) Selecting the “Override mode” as the 5.10 procedures.

Under “Override mode”, the system only allow one delegate unit be activated. Press the microphone ON/OFF push-button on one delegate unit will deactivate the previous active delegate unit, and activate its own microphone

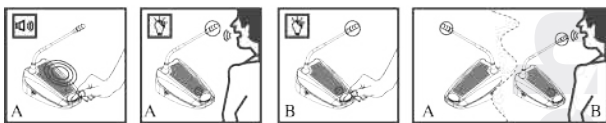
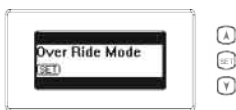

5.13 Chairman only mode

1) Selecting the “Chairman only mode” as the 5.10 procedures.

Under “Chairman only mode”, the system only allow chairman units be activated. All delegate units will be deactivated.



6. Technical Data

6.1 Electrical and Electro-Acoustical Characteristics

6.1.1 CS-1CU

Voltage: VAC100~264, 50/60Hz

Current consumption: MAX 0.9A(100VAC) 0.3A(240VAC)

DC supply to contribution units: $\pm 15V$

Line, telephone coupler and insertion in/outputs (unbalanced)

- Input sensitivity: -14dBV/+11dBV (hominal/maximum)
- Input impedance: $33K\Omega$
- Output level: -14dBV/+11dBV (hominal/maximum)
- Output impedance: 500Ω

Recorder in/output (unbalanced)

- Input sensitivity: -20dBV/+5dBV (hominal/maximum)
- Input impedance: $47K\Omega$ (for L & R channel)
- Adjustment: -20dBV/+5dBV
- Output level: +0/-30dB
- Output impedance: 500Ω

External microphone input (balanced)

- Input sensitivity: -56dBV (-6dBV via included adapter)
- Adjustment: +6dBV/-6dB
- Phantom supply: $12V \pm 1V$, $2 \times 680\Omega$ ($\pm 2\%$)

Headphone output

- Output level: -8dBV/+2dBV
- Output Impedance: 22Ω

System limits

Number of delegate/chairman units connected to CU

- Maximum in total: 50
- Maximum per Trunk output: 25
- Maximum trunk length using CS-1: standard cabling: 100m (328 ft)

6.1.2 CS-1CH & DU

Gooseneck Microphone:

- Type: Back Electret Condenser
- Frequency Response: 50 to 18,000Hz
- Polar Pattern: Cardioid
- Max. SPL for 1% THD: 125dB
- Gooseneck Length: 15" (400mm)

6.2 Mechanical Specifications

6.2.1 CS-1CU

Dimensions (HxWxD) : 360*150*90 mm

Weight : 1745 g

6.2.2 CS-1CH & DU

Dimensions (HxWxD) without mic. : 170*115*65 mm

Length of mic. : 400 mm

Weight : 1100g

6.3 General Specifications

Environmental Conditions

Temperature range

Storage and transport: -20 to 70°C (-4 to +158°F)

Operational: +5 to 45°C (+41 to +113°F)

Ambient humidity

Storage and transport: 0%-99% RH

Operational: 20%-95% RH

Air pressure: 600mBar-11000mBar

Safety: EN60065

6.4 Pin configuration

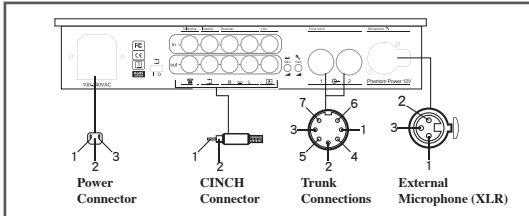

Trunk Connections

- 1) Audio contribution line
- 2) GND
- 3) Audio distribution line
- 4) Control line 1
- 5) Control line 2
- 6) V+ supply
- 7) V- supply

External Microphone (XLR)

- 1) GND (0V, phantom supply)
- 2) Signal + (+12V, Phantom supply)
- 3) Signal - (+12V, Phantom supply)

CINCH Connector

- 1) Signal +
- 2) Signal -

Power Connector

- 1) Mains
- 2) Earth
- 3) Mains

Headphone Jack-Plug (3.5mm)

- 1) Tip (Signal +)
- 2) Ring (Signal -)
- 3) Sleeve (Electrical earth/screen)

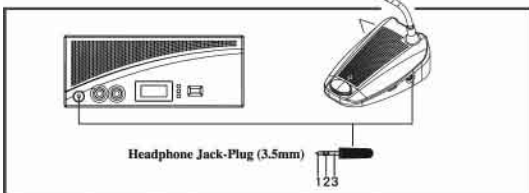

Installation Microphone

CS SERIES



59508-012-03