



FEEL JOYO ENJOY MUSIC

# **GEM BoX**

Guitar Multi-Effects Processor

# **Owner's Manual**

# Contents

<b>Precautions</b> .....	02
<b>Items Explanation</b> .....	03
<b>Main Features</b> .....	04
<b>Battery Operation</b> .....	04
<b>Panel Instruction</b> .....	05
<b>Connections</b> .....	07
<b>Operation</b> .....	08
Patch Selecting .....	08
Drum Rhythm .....	09
Tuner.....	10
Expression Pedal .....	11
Patch Editing.....	13
Patch Storing/Copying.....	15
Patch Pre-Select Recall Function.....	16
Factory Reset.....	17
<b>Effects Explanation</b> .....	18
<b>Specification</b> .....	22
<b>Troubleshooting</b> .....	23
<b>Appendix</b> .....	24
Patch List.....	24
Drum Rhythm List .....	25

# Precautions

**\* PLEASE READ CAREFULLY BEFORE PROCEEDING \***

## **Power Supply**

Please connect the designated AC adapter to an AC outlet of the correct voltage.

Please be sure to use only an AC adapter which supplies 9V DC, 300 mA, center minus.

Unplug the AC power adapter when not using or during electrical storms.

## **Connections**

Always turn off the power of this and all other equipments before connecting or disconnecting, this will help prevent malfunction and / or damage to other devices. Also make sure to disconnect all connection cables and the power cord before moving this unit.

## **Location**

To avoid deformation, discoloration, or other serious damage, do not expose this unit to the following conditions:

- Direct sunlight
- Heat sources
- Magnetic fields
- Extreme temperature or humidity
- Excessive dusty or dirty location
- High humidity or moisture
- Strong vibration or shock

## **Interference with other electrical devices**

Radios and televisions placed nearby may experience reception interference. Operate this unit at a suitable distance from radios and televisions.

## **Cleaning**

Clean only with a soft, dry cloth. If necessary, slightly moisten the cloth. Do not use abrasive cleanser, cleaning alcohol, paint thinners, wax, solvents, cleaning fluids, or chemical-impregnated wiping cloths.

## **Handling**

Do not apply excessive force to the switches or controls.

Do not let paper, metallic, or other objects into this unit.

Take care not to drop the unit, and do not subject it to shock or excessive pressure.

# Items Explanation

## **Patch**

A patch is comprised of information about the on/off status and effect parameter settings used in each module.

## **Bank**

A bank is a group of ten patches. GEM Box has 8 banks, labelled with numbers 0 to 3 (unchangeable preset banks) and letters A to d (editable user banks).

## **Effect module**

A patch can be thought of as a combination of up to 8 single effects. Each such effect is referred to as an effect module.

## **Effect type**

Some effect modules have several different effects which are referred to as effect types. Only one of these can be selected at a time.

## **Effect parameter**

All effect modules have various parameters that can be adjusted. These are called effect parameters or simply parameters. When thinking of an effect module as a compact effect, the parameters change the tone and effect intensity similar to the knobs on the device.

## **Mode**

Mode is the status of different function keys and controls, GEM Box has Play Mode for selecting and playing patches, Rhythm Mode for editing a drum rhythm, Edit Mode for modifying effects, and Store Mode for saving patches.

# Main Features

- 8 Effect Modules
- 60 Effect Types
- 40 Preset Patches
- 40 User Patches
- 40 Drum Rhythms
- Assignable Expression Pedal
- Precise Tuning function
- Patch Pre-Select Recall function
- Compact operation interface
- Lightweight and tiny for easy transportation
- AC adapter 9V DC power supply
- AA battery (x4) power supply

## Battery Operation

1. Turn off the GEM Box and open the battery holder on the bottom.
2. Insert 4 AA batteries and close the battery holder.

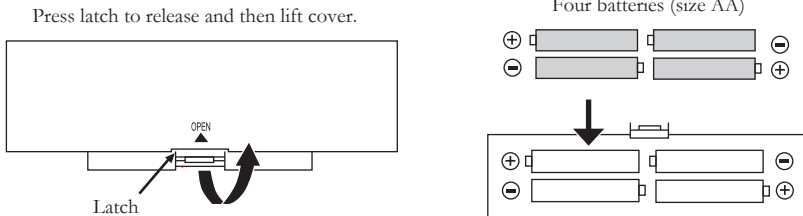

**Note:** When the batteries are getting low, the display will show  to indicate this situation.

**Note:** When using batteries, it is suggested to disconnect the guitar cable plug from the [INPUT] jack when not using the device, to conserve battery power.

# Panel Instruction

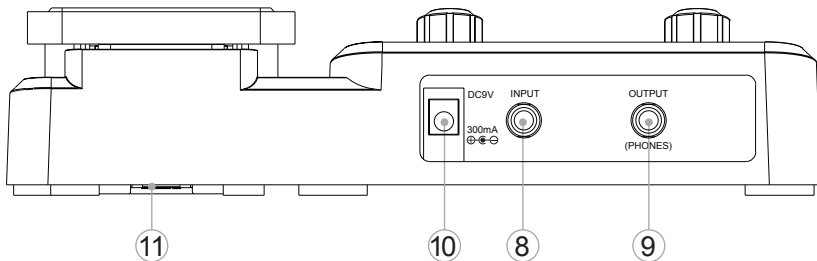
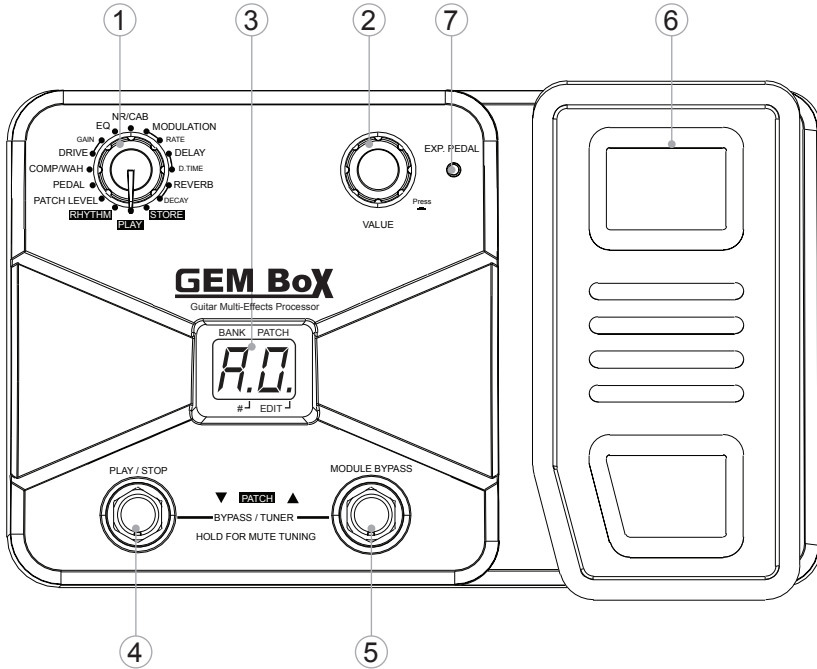

- 01 Module Selector:** Switches between every function module. In patch edit mode, this knob selects the module/parameter for operation.
- 02 VALUE Knob with Enter Button:** Dial the knob for setting master level, or changing parameter values. Press the button to switch effect type, ensure storing, etc.
- 03 LED Display:** Shows bank and patch numbers, setting values, and other information for operating.
- 04 PATCH – [PLAY/STOP] Footswitch:** Selects patches (backwards), controls the tuner, start/stop drum rhythm, and other functions.
- 05 PATCH + [MODULE BYPASS] Footswitch:** Selects patches (forwards), controls the tuner, bypass effect module, and other functions.
- 06 Expression Pedal:** Adjusts volume or some effect parameters.
- 07 EXP. PEDAL LED:** Indicates the status of the expression pedal.
- 08 INPUT Jack:** 1/4" mono audio jack, for connecting guitar. When operating GEM Box on batteries, plugging guitar cable into this jack will turn on the unit.
- 09 OUTPUT [PHONES] Jack:** 1/4" stereo audio jack, for connecting headphone or guitar amplifier. Using a mono cable can output the signal to an amplifier, or use a Y cable to output the signal to two amplifiers. Also can plug a stereo headphone into this jack.
- 10 DC 9V Jack:** For power supply, use a 9-volt DC regulated by AC adapter, 300mA (plug polarity is positive on the barrel and negative in the center).
- 11 Battery Holder:** For installing batteries (AA x 4).

# Connections

AC adapter

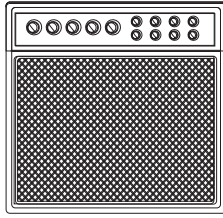
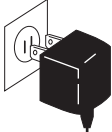

Guitar amplifier

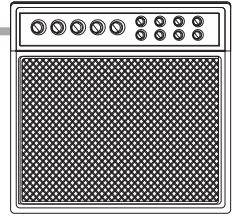

Guitar amplifier

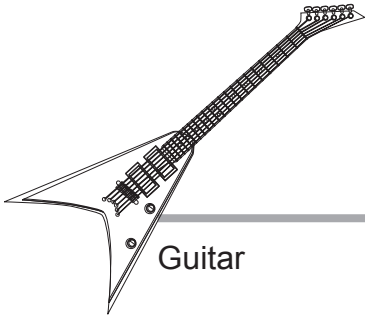
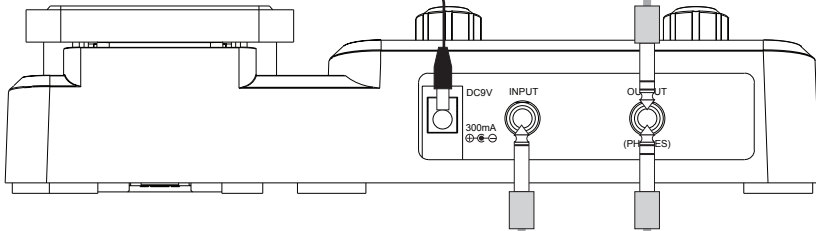

Guitar



Headphones



# Operation

## Patch Selecting

### 01 Power On

Plug the cable of AC Adapter (9V, 300mA, center minus) into the [DC 9V] Jack, when using batteries, plug the guitar cable into this jack will turn the device on.

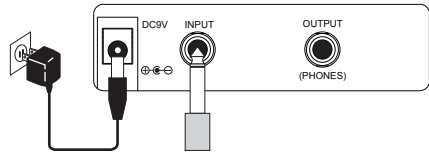

### 02 Selecting Patches

Set the Module Selector to [PLAY], the LED display will show the information of bank and patch number, step on [PATCH +/-] footswitch to change patches (Hold one footswitch to switch patches quickly).



Pressing [PATCH +] footswitch time and again (or holding [PATCH +] footswitch) cycles through patches in the order A0~A9 ... 00~09, 00~09... 00~09, A0. Pressing or holding [PATCH -] footswitch will switch patches in the opposite order.

### 03 Adjusting the master volume

Set the Module Selector to [PLAY], rotate [VALUE] knob to adjust the master volume of GEM Box (when setting up the master volume, LED display will show the current level). The range of master volume is 00~99, 70 is the default value.



# Drum Rhythm

## 01 Selecting Drum Rhythm Type

Set the Module Selector to [RHYTHM], LED display will show the rhythm type firstly, and then rotate the [VALUE] knob to select the rhythm type (01~40).

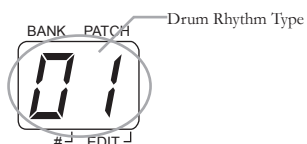

## 02 Adjusting Drum Rhythm Volume

Set the Module Selector to [RHYTHM], LED display will show the rhythm type firstly, and then press [VALUE] button once, at that time, LED displays the drum rhythm volume, then rotate the [VALUE] knob to change the rhythm volume (00~09, the default value is 05).

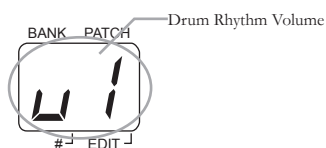

## 03 Changing Drum Rhythm Tempo

Set the Module Selector to [RHYTHM], LED display will show the rhythm type firstly, and then press [VALUE] button twice, at that time, the number displayed in LED indicates the tempo of drum rhythm, then rotate the [VALUE] knob to change tempo.

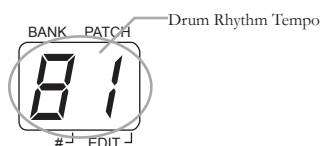

The range of the displaying tempo value is 00~99, indicate the real tempo 60~270 BPM, each rhythm has its own default tempo value.

## 04 Start/Stop Drum Rhythm

When in RHYTHM mode or EDIT mode (Except PLAY/STORE mode), press [PATCH -] footswitch will start the drum rhythm. When the rhythm is playing, press [PATCH -] footswitch again to stop.

*Note: You can't stop the drum rhythm in PLAY/STORE mode.*

# Tuner

## 01 Entering Bypass Tuning Mode

When in PLAY mode, press both [PATCH -] and [PATCH +] footswitches together to enter bypass tuning mode. LED will display for 1 second, then begin to show tuning indication.



## 02 Entering Mute Tuning Mode

When in PLAY mode, hold both [PATCH -] and [PATCH +] footswitches together longer than 2 seconds to enter mute tuning mode. In course of this operation, LED will display for 1 second then turn to display , when releasing the footswitch, LED begin to show tuning indication.

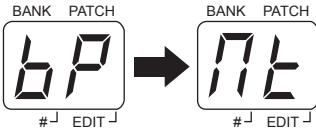

*Note: In mute tuning mode, no sound will phonate through the output of GEM Box.*

## 03 Tuning

Play one guitar string at a time, and adjust the guitar pitch as LED's instruction.

The left side shows the current pitch.

A - A A# - A. B - b  
C - C C# - C. D - d  
D# - d. E - E F - F  
F# - F. G - G G# - G.

The right side indicates how much the tuning is off.

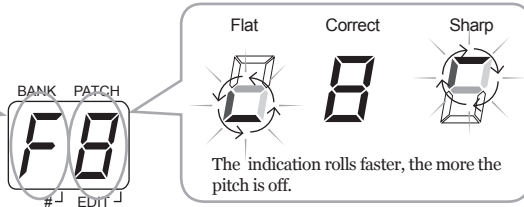

## 03 Quit Tuner

When in tuning mode, press both [PATCH -] and [PATCH +] footswitches together or anyone of these 2 footswitches to quit tuning state. GEM Box will return to PLAY mode.

# Expression Pedal

## 01 Volume Control

If the [EXP. PEDAL] LED is not lighted up, the expression pedal will be a volume pedal for controlling the master level of GEM Box.

## 02 Effect Control

If the [EXP. PEDAL] LED is lighted up, the expression pedal will be an expression pedal for controlling the effect's parameter which was set up in PEDAL setting.

## 03 Control Assign

Set the Module Selector to [PEDAL], the LED display will show the controlling object of the expression pedal.

There are 7 kinds of parameter can be controlled by the pedal, LED will show the type of parameter in control:

Control Target	LED Display	Control Parameter
Wah	$WR$	Central Frequency
Drive Gain	$dG$	Gain
Modulation Rate	$Mr$	Rate/Pitch/Frequency
Modulation Depth	$Md$	Depth
Delay Time	$dT$	Time
Delay Feedback	$dF$	Feedback
Reverb Level	$rL$	Reverb Level

Rotate [VALUE] knob to choose one kind of controlling target, then the expression pedal will work with the corresponding parameter.

**Note:** There will be a symbol  $\blacktriangleright$  behind the effect parameter which can be controlled by the pedal (refer to Effect Explanation for detail).

**Note:** If the effect module of the chosen target was not turned on, the pedal will be of no effect.

**Note:** Pedal setting can be stored in patch.

**Note:** The expression pedal will be effective in EDIT mode.

#### 04 Switch Control Mode (Volume-Effect)

Push down the expression pedal at full tilt to switch the control mode from volume control to effect control, and [EXP.PEDAL] LED will shift from extinguish to light. It also can switch the control mode from effect control to volume control, [EXP.PEDAL] LED will shift from light to extinguish.

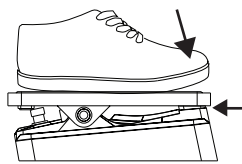

Push strongly, so that pedal touches here

#### 05 Pedal Reset

The responsivity of the expression pedal on GEM Box can be reset as necessary. If the effect change seems insufficient when pushing the pedal down, or if the volume or tone changes excessively even when the pedal is only lightly pushed, or if it's hard to switch the pedal mode, adjust the pedal as follows:

- Set the Module Selector to [PEDAL] and hold down [VALUE] button while power on, the indication  $\overline{UP}$  will appear on the LED display, and then release the [VALUE] button.
- Fully raise the expression pedal and press [VALUE] button once, the indication  $\overline{dn}$  will appear on the LED display.
- Push the expression pedal fully down and press [VALUE] button again, the indication  $\overline{Pr}$  will appear on the LED display.
- Push strongly down the expression pedal at full tilt and press [VALUE] button once more. The Pedal Reset adjustment is completed, and GEM Box will return to the play mode. If the indication  $\overline{Er}$  is shown, press [VALUE] button and repeat the procedure from step b.

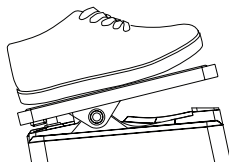

Fully raise

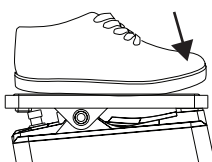

Fully down

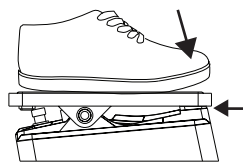

Push strongly, so that pedal touches here

# Patch Editing

## 01 Select Effect Module

Set the Module Selector to the effect module which you want to edit, the available setting options are listed below:

- 01.PATCH LEVEL (Para)
- 02.PEDAL (Para)
- 03.COMP/WAH (Type & Para)
- 04.DRIVE (Type)
- 05.GAIN (Para)
- 06.EQ (Type & Para)
- 07.NR/CAB (Type & Para)
- 08.MODULATION (Type & Para)
- 09.RATE (Para)
- 10.DELAY (Type & Para)
- 11.D.TIME (Para)
- 12.REVERB (Type & Para)
- 13.DECAY (Para)

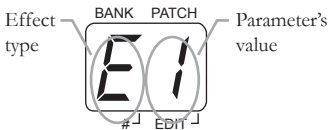
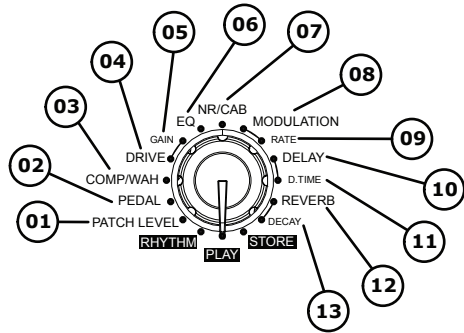

**Type & Para:** The effect type (left side of the display) and parameter's value (right side of the display) are adjusted simultaneously.

**Type:** Only select the effect type.

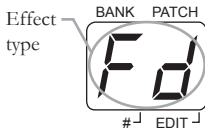

**Para:** Only adjust the parameter's value.



In fact, the GAIN module is a part of DRIVE module, the RATE module is a part of MODULATION module, the D.TIME module is a part of DELAY module, and the DECAY module is a part of REVERB module. They are all parameter's value setting module which belongs to the previous effect module.

## 02 Change Setting

Press [VALUE] knob to change effect/parameter type ahead, hold and rotate [VALUE] knob to change effect/parameter type ahead (clockwise) or backwards (anticlockwise), rotate [VALUE] knob to set a new value of the effect type or parameter. As long as the selected item's value changes, a dot (•) will appear in the bottom right of the display. This indicates that a setting has been changed from the currently stored value.

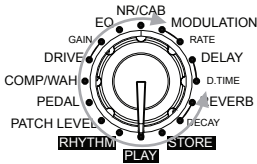

Dot indicates that setting has been changed



## 03 Bypass an Effect Module

When adjusting an effect in EDIT mode, press [MODULE BYPASS] / [PATCH +] footswitch to bypass this effect module, the indication **0F** will appear on the display and the module will be turned off. Pressing [MODULE BYPASS] / [PATCH +] switches once more will return the setting to the previous condition.

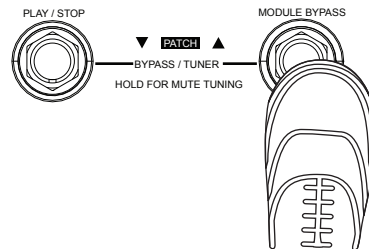

## 04 Adjusting the Patch Level

Set the Module Selector to [PATCH LEVEL], rotate [VALUE] knob to adjust the volume of a patch, LED display will show the current level.

The range of patch level is **00**~**99**.

**Note:** If you return to [PLAY] module and select another patch, the changes you have made in edit mode will be lost unless you store the patch first.

# Patch Storing/Copying

## 01 Enter Storing Mode

Set the Module Selector to [STORE] to enter storing mode, the display will show the current editing patch's number.

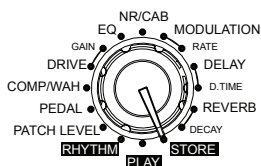

## 02 Storing/Copying Patch

When in [STORE] mode, press [VALUE] button once to do the storing, the patch's number on the display will begin to flash, at that time, rotate [VALUE] knob or press [PATCH -] / [PATCH +] footswitch to change patch number, when you got the expectant position, press [VALUE] button again to confirm the patch storing, the patch's number on the display will stop flashing.



**Note:** To cancel the store process, rotate the Module Selector to another position, well then the patch will not be saved.

**Note:** An edited patch can be stored in a user bank (A~d), it can not be stored in a preset patch (0~3).

**Note:** Storing an existing patch in another location can create a copy.



# Patch Pre-Select Recall Function

Patch Pre-Select function can let you select the patch first but not to activate it, and then perform an additional step to activate the patch. To use this function, conform to the following instructions:

1. Before power on, hold down the [PATCH +] footswitch, and then power to the GEM Box, **PS** will appear on the display and last flashing for 3 seconds, it indicates setting up to Patch Pre-Select function successfully.

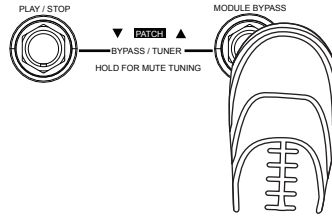

2. In play mode, select the patch to use next. The selected new bank and patch's number flash on the display, but the sound does not change yet.



3. Press both [PATCH -] and [PATCH +] footswitches together, the selected patch will be activated, the sound changes, and the display will stop flashing.

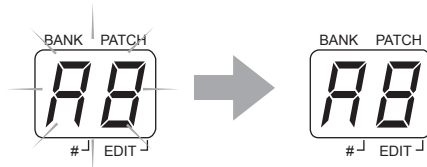
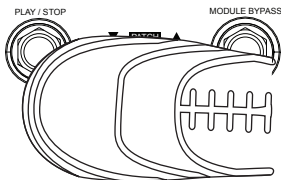

4. To return the normal patch selecting method, turn the power off and then on again. The Patch Pre-Select function will not preserve when power on again.

# Factory Reset

Factory Reset function will initialize all setting of GEM Box. All the user patches will be erased and overwritten by the preset patches. To do the factory reset, conform to the following instructions:

Before power on, set the Module Selector to [PLAY], hold down the [PATCH -] and [PATCH +] footswitch and the [VALUE] button simultaneously, and then power to the GEM Box, **FS** will appear on the display and last flashing.

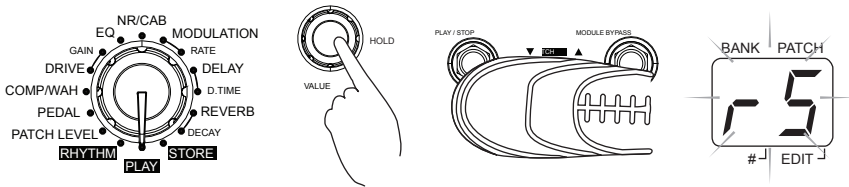

At that time, press [VALUE] button to confirm, **FS** will be flashing in a faster speed for 2 seconds, then turn to display **FS** at a steady status for 3 second, then back to the normal state, the factory reset operation have been done.

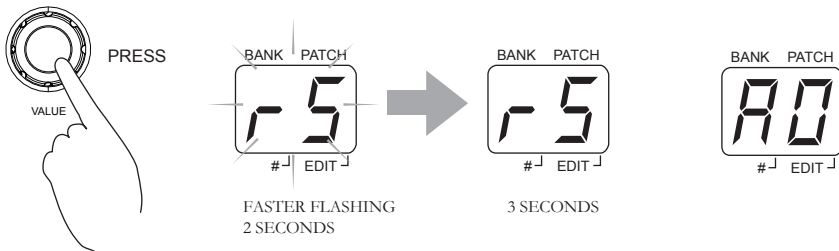

**Note:** If you want to quit Factory Reset halfway, move the Module Selector to another location, then the Factory Reset will be canceled.

# Effects Explanation

## 01 General Instruction

### Effect Chain

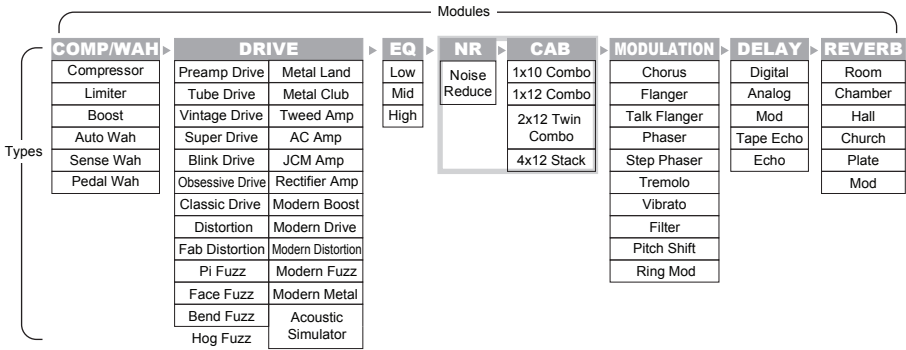

GEM Box has 8 effect modules, 60 types of effect in total, can offer up to 8 simultaneous effects (NR/CAB module can offer 2 effects at a time).

Each effect module has several different effect types, only one type can be selected at a time. All effect types have various parameters that can be adjusted, the parameters change the tone and effect intensity similar to the knobs on the device.

## 02 Explain the Effects Modules/Types/Parameters

### COMP/WAH Module

Type Name	Display	Effect Explanation
Compressor		This effect is used for controlling dynamics of the signal, it limits high-level signals and boosts low-level signals. The parameter's value controls the <b>Depth</b> .
Limiters		This effect limits high-level signals to avoid overload. The parameter's value controls the <b>Depth</b> .
Boost		This effect can enhance the gain and dynamic of the signal. The parameter's value controls the <b>Gain</b> .
Auto Wah		This effect creates a recurrent wah-wah sound. The parameter's value controls the <b>Rate</b> .

Sense Wah		This effect varies wah sound according to picking intensity. The parameter's value controls the <b>Sensitivity</b> .
Pedal Wah		This effect varies wah sound by controlling the expression pedal. The parameter's value controls the <b>Central Frequency</b>



This mark means the parameter can be controlled by the expression pedal if corresponding type was chosen in PEDAL module.

## DRIVE Module

Type Name	Display	Effect Explanation
Preamp Drive		Based on a DOD® Overdrive Preamp/250 *
Tube Drive		Based on an Ibanez® TS9 (TUBE SCREAMER®) *
Vintage Drive		Based on a BOSS® OD-1 (Over Drive) *
Super Drive		Based on a BOSS® SD-1 (SUPER OverDrive) *
Blink Drive		Based on a Voodoo Lab® Sparkle Drive *
Obsessive Drive		Based on a Fulltone® OCD® (Obsessive Compulsive Drive™) *
Classic Drive		Based on a ProCo™ The Rat™ *
Distortion		Based on a BOSS® DS-1 (Distortion) *
Fab Distortion		Based on a Danelectro® DD1 Fab Tone™ *
Pi Fuzz		Based on an Electro-Harmonix® Big Muff Pi® *
Face Fuzz		Based on a Dallas-Arbitr FUZZFACE™ *
Bend Fuzz		Based on a Colorsound Tonebender *
Hog Fuzz		Based on an Electro-Harmonix® Hog's Foot *
Metal Land		Based on a BOSS® MT-2 (Metal Zone) *
Metal Club		Based on an Ibanez® SM-7 (Smash Box) *
Tweed Amp		Based on a Fender® Tweed Bassman® amp *
AC Amp		Based on a Vox® AC30 amp *
JCM Amp		Based on a Marshall® JCM800 amp *
Rectifier Amp		Based on a Mesa Boogie® Dual Rectifier® amp *
Modern Boost		Factory Design
Modern Drive		Factory Design
Modern Distortion		Factory Design
Modern Fuzz		Factory Design
Modern Metal		Factory Design
Acoustic Simulator		Factory Design
Gain		Control the Gain of distortion effects and the Tone of Acoustic Simulator effect.

Manufacturer names and product names mentioned in this list are trademarks or registered trademarks of their respective owners. They are trademarks of other manufacturers and were used merely to identify whose sounds were reviewed in the creation of this product.





### EQ Module

Type Name	Display	Effect Explanation
Low		This controls the bottom band of the equalizer, the central frequency is 160Hz. The parameter's value controls the <b>Gain</b> .
Mid		This controls the middle band of the equalizer, the central frequency is 800Hz. The parameter's value controls the <b>Gain</b> .
High		This controls the high band of the equalizer, the central frequency is 3.2KHz. The parameter's value controls the <b>Gain</b> .







EQ Gain-Display Comparison:







Para-Display	1	2	3	4	5	6	7	8	9
Gain	-12dB	-9dB	-6dB	-3dB	0dB	3dB	6dB	9dB	12dB

### NR/CAB Module







Type Name	Display	Effect Explanation
Noise Reduction		Noise Reduction function only, it will reduce the noise of input signal. The parameter's value controls the NR's <b>Intensity</b> .
Noise Reduction + 1x10 Combo		NR function + 1x10 Combo guitar amp cabinet simulator. The parameter's value controls the NR's <b>Intensity</b> .
Noise Reduction + 1x12 Combo		NR function + 1x12 Combo guitar amp cabinet simulator. The parameter's value controls the NR's <b>Intensity</b> .
Noise Reduction + 2x12 Twin Combo		NR function + 2x12 Twin Combo guitar amp cabinet simulator. The parameter's value controls the NR's <b>Intensity</b> .
Noise Reduction + 4x12 Stack		NR function + 4x12 Stack guitar amp cabinet simulator. The parameter's value controls the NR's <b>Intensity</b> .

### MODULATION Module







Type Name	Display	Effect Explanation
Chorus ➤		This effect creates a shining dimensional sound. The parameter's value controls the <b>Depth</b> .
Flanger ➤		This effect produces an undulating and floating feeling sound. The parameter's value controls the <b>Depth</b> .
Talk Flanger ➤		This effect produces another kind of flanger sound. The parameter's value controls the <b>Depth</b> .
Phaser ➤		This effect creates a pulsing-like sound. The parameter's value controls the <b>Depth</b> .
Step Phaser ➤		This effect produces a phaser sound with more pulsing feeling. The parameter's value controls the <b>Depth</b> .
Tremolo ➤		This effect periodically influences the volume of the signal. The parameter's value controls the <b>Depth</b> .
Vibrato ➤		This effect periodically influences the pitch of the signal. The parameter's value controls the <b>Depth</b> .

Filter ➤		This effect produces a sweeping filter sound. The parameter's value controls the <b>Depth</b> .
Pitch Shift ➤		Transfer the pitch and blend with the original note. The parameter's value controls the <b>Mix</b> .
Ring Mod ➤		Produces sounds like ring bell. The parameter's value controls the effect's <b>Level</b> .
Rate ➤		Control the speed of effects, except Pitch Shift, Ring Mod
Pitch ➤		Control the pitch range when use Pitch Shift
Frequency ➤		Control the frequency when use Ring Mod

### DELAY Module

Type Name	Display	Effect Explanation
Digital ➤		Repeat the signal with no special processing, creates the most clean delay sound. The parameter's value controls the <b>Feedback</b> .
Analog ➤		Simulates an analog delay equipment, produces a warm and vintage delay sound. The parameter's value controls the <b>Feedback</b> .
Mod ➤		Adds chorus effect to the delay sound, has more extensive spacy feeling. The parameter's value controls the <b>Feedback</b> .
Tape Echo ➤		Simulates an Tape Echo machine, creates a tape-like delay sound The parameter's value controls the <b>Feedback</b> .
Echo ➤		Simulates the real Echo, authentic and natural delay sound. The parameter's value controls the <b>Feedback</b> .
Delay Time ➤		The value indicates the delay time from 10ms~1500ms.

### REVERB Module

Type Name	Display	Effect Explanation
Room ➤		Simulates the acoustics of a Room. The parameter's value controls the Reverb's <b>Level</b> .
Chamber ➤		Simulates the acoustics of a Chamber. The parameter's value controls the Reverb's <b>Level</b> .
Hall ➤		Simulates the acoustics of a concert Hall. The parameter's value controls the Reverb's <b>Level</b> .
Church ➤		Simulates the acoustics of a big church. The parameter's value controls the Reverb's <b>Level</b> .
Plate ➤		Simulates a Plate reverberation. The parameter's value controls the Reverb's <b>Level</b> .
Mod ➤		Add Chorus effect to a Hall reverb. The parameter's value controls the Reverb's <b>Level</b> .
Decay		Control the Decay of Reverb effect

# Specification

<b>No. of Effect Modules:</b>	Max. 8 simultaneous modules
<b>No. of Effect Types:</b>	60
<b>Preset Patch Memory:</b>	40 Patches (4 Banks, each bank has 10 patches)
<b>User Patch Memory:</b>	40 Patches (4 Banks, each bank has 10 patches)
<b>Sampling Frequency:</b>	48 kHz
<b>A/D converter:</b>	16 bit, 384 times over sampling
<b>D/A converter:</b>	16 bit, 384 times over sampling
<b>Guitar Input:</b>	1/4" monaural jack, input impedance 470 k Ohms
<b>Output:</b>	1/4" stereo jack (doubles as line/headphone jack)
<b>Power requirements:</b>	AC adapter 9V DC, 300 mA (center minus plug) or 4 IEC R6 (size AA) batteries
<b>Dimensions:</b>	158 mm (D) x 237mm (W) x 63 mm (H)
<b>Weight:</b>	730 g (without batteries)
<b>Accessories:</b>	Owner's Manual, AC adapter 9V DC

# Troubleshooting

## **Can not power on**

Check power connection.

----- *Make sure the power is connected correctly.*

Check the adapter.

----- *Make sure the adapter's type is DC9V/300mA/center minus.*

When using battery, check whether the cable is inserted entirely to the INPUT jack.

When using battery, check the battery, is the battery low or dead?

----- *Make sure the battery is at work and the INPUT jack is connected with an audio cable.*

## **No sound or low volume**

Check connection of cables.

----- *Make sure all the cables are connected firmly.*

Check the volume of guitar and amplifier.

----- *Make sure each equipment's volume is set to an appropriate level.*

## **High noise**

Check the adapter.

----- *Make sure the adapter's type is DC9V/300mA/center minus.*

Check the cables.

----- *Make sure the cables are connected firmly and have no quality problem.*



# Appendix

## Patch List

Patch	Patch Name	Pedal Assign	Patch	Patch Name	Pedal Assign
<i>00/00</i>	Super Lead	Volume	<i>00/20</i>	Wet Clean	Reverb Level
<i>01/01</i>	Pure Land	Volume	<i>01/21</i>	California Riff	Volume
<i>02/02</i>	Vintage Tremolo	Tremolo Rate	<i>02/22</i>	Rough Whip	Volume
<i>03/03</i>	Obsessive Drive	Volume	<i>03/23</i>	Preamp Drive	Drive Gain
<i>04/04</i>	Slap Blues	Volume	<i>04/24</i>	Acoustic Clean	Volume
<i>05/05</i>	Peaceful Plain	Delay Time	<i>05/25</i>	Rolling Wheel	Tremolo Depth
<i>06/06</i>	Jimi's Vib	Vibrato Rate	<i>06/26</i>	Mad Wing	Phaser Depth
<i>07/07</i>	Funky Phaser	Phaser Rate	<i>07/27</i>	Modern Metal	Volume
<i>08/08</i>	Traditional Metal	Volume	<i>08/28</i>	Whirly Room	Flanger Rate
<i>09/09</i>	Power Solo	Drive Gain	<i>09/29</i>	Spacy Drive	Delay Time
<i>10/10</i>	Texas Rhythm	Volume	<i>10/30</i>	Bounce Recorder	Phaser Rate
<i>11/11</i>	Blues Solo	Volume	<i>11/31</i>	Brit Melon	Drive Gain
<i>12/12</i>	Wah Wah	Filter Rate	<i>12/32</i>	Pink Wall	Delay Level
<i>13/13</i>	Lite Flanger	Flanger Rate	<i>13/33</i>	Confused Room	Reverb Level
<i>14/14</i>	Misty Coast	Flanger Depth	<i>14/34</i>	Jumping Squirrel	Phaser Depth
<i>15/15</i>	Randy Lead	Volume	<i>15/35</i>	Broken TV	Filter Depth
<i>16/16</i>	Fuzzy Echo	Delay Level	<i>16/36</i>	Pop Dist	Volume
<i>17/17</i>	Wall Shadow	Delay Time	<i>17/37</i>	Punch Back	Delay Time
<i>18/18</i>	Mystic River	Reverb Level	<i>18/38</i>	Vintage Drive	Volume
<i>19/19</i>	Infinite Mirror	Delay Time	<i>19/39</i>	Tele Ring	Ring Frequency

## Drum Rhythm List

No.	Type	Time Signature	Default Tempo
01	8Beat1	4/4	120 BPM
02	8Beat2	4/4	120 BPM
03	8Beat3	4/4	120 BPM
04	8Beat4	4/4	120 BPM
05	8Beat5	4/4	120 BPM
06	16Beat1	4/4	120 BPM
07	16Beat2	4/4	120 BPM
08	16Beat3	4/4	120 BPM
09	16Beat4	4/4	120 BPM
10	16Beat5	4/4	120 BPM
11	3/4Beat	3/4	120 BPM
12	6/8Beat	6/8	120 BPM
13	Pop	4/4	120 BPM
14	Funk	4/4	108 BPM
15	Hard Rock	4/4	135 BPM
16	Metal	4/4	120 BPM
17	Punk	4/4	162 BPM
18	Hip Hop	4/4	96 BPM
19	Trip Hop	4/4	84 BPM
20	Dance	4/4	120 BPM
21	Break Beat	4/4	156 BPM
22	Drum n' Bass	4/4	180 BPM
23	Blues	4/4	108 BPM
24	Jazz	4/4	120 BPM
25	Swing	4/4	144 BPM
26	Fusion	4/4	120 BPM
27	Reggae	4/4	90 BPM
28	Latin	4/4	135 BPM
29	Country	4/4	114 BPM
30	Bossanova	4/4	120 BPM
31	Rumba	4/4	135 BPM
32	Tango	4/4	120 BPM
33	Polka	4/4	120 BPM
34	World	4/4	108 BPM
35	Metro 2/4	2/4	120 BPM
36	Metro 3/4	3/4	120 BPM
37	Metro 4/4	4/4	120 BPM
38	Metro 5/4	5/4	120 BPM
39	Metro 6/8	6/8	120 BPM
40	Metro	None	120 BPM





---

**JOYO TECHNOLOGY CO., LTD**

Add: 2/F, Lushi Industry Building, No.28 Block, Bao'an District, Shenzhen, 518101 China  
Int.Sales Email: [info@joyoaudio.com](mailto:info@joyoaudio.com) Int.Sales Tel: 0086-755-29765381  
After-sales Tel: 0086-755-29765380  
[www.joyoaudio.com](http://www.joyoaudio.com)