

CS-120 Series

Digital Conference System

JTS[®] PROFESSIONAL CO., LTD.

No. 148, 9th Industry Road, Ta-Li Industrial Park,
Taichung City, Taiwan, R.O.C.

Tel: 886-4-24938803 Fax: 886-4-24914890

E-mail: jts@jts.com.tw

www.jts.com.tw



59508-068-06

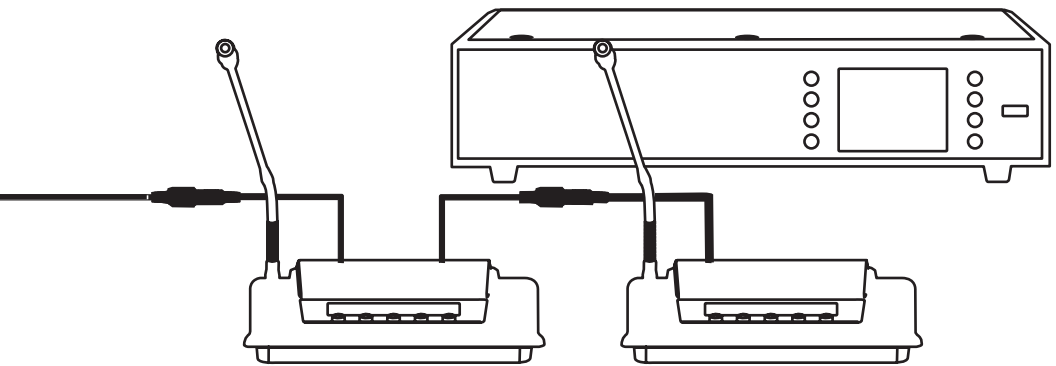

CS-120 Series

Digital Conference System Product Manual

Contents

- A. Product Functions and Features — 1
- B. External Functions — 3
 - 2-1 Control Unit — 3
 - 2-1-1 Front Panel — 4
 - 2-1-2 Back Panel — 5
 - 2-2 Extension Unit — 7
 - 2-3 CS-120CH Chairman Unit / CS-120DU Delegate Unit 8
 - 2-4 Pluggable Gooseneck Microphone — 10
- C. System Connection — 11
 - 3-1 Conference Unit Connection — 11
 - 3-2 Connection of Extension Unit (EXU) and Control Unit (CU) 13
 - 3-3 Peripheral Equipment Connection — 14
 - 3-4 Video Tracking Equipment Connection — 15
- D. System Set-up and Operation — 16
 - 4-1 Initialization and Self-examination — 16
 - 4-2 System Self-examination — 17
 - 4-3 Main Directory — 18
 - 4-3-1 Network Address — 19
 - 4-3-2 Unit Number — 19
 - 4-3-3 Unit Settings — 21
 - 4-3-4 Video Settings — 25

4-3-5 Language Settings	27
4-3-6 Unit Test (Cannot Access under “Voice” Mode)	27
4-3-7 Record Settings	31
4-3-8 CU Information	33

E. Instructions 34

5-1 Unit Number	34
5-2 Speak	35
5-3 Vote	37
5-4 Volume Control	37
5-5 LCD Display of Conference Unit	37
5-6 Exclusive Functions of Chairman Unit	38

F. Equipment Installation 41

6-1 Extension Unit (EXU) and Control Unit (CU)	41
6-2 Conference Unit	41
6-3 Electric Cable Connection, 7PIN Plug and Outlet	42
6-4 Audio Connection of CS-120 Conference System	43
6-5 Other Accessories	44

G. Operating Environment and Maintenance 46

H. Technical Specifications 48

8-1 System Specifications	48
8-2 Control Unit (CU)	49
8-3 Conference Unit	50

A.Product Functions and Features

1-1 The Number of Active Microphones and Operation Modes

- The limit of active microphones (1/2/4) and of speaking time
- Four operation modes set up through control unit:
 - “Open” mode: When reaching the maximum number of active microphones, press the microphone button (TALK) to register a speaking (enter speaking condition automatically in order).
 - “Override” mode: When reaching the maximum number of active microphones, press the microphone button to control and override (turn off) active microphones (override the active microphones in order).
 - “Voice” mode: Auto voice control mode. The user can set up the sensitivity of activating the microphones.
 - “Apply” mode: A delegate can press speaking button to apply for a speaking, and after the chairman approves the application, the delegate can speak.
- In “Open/Override/Apply” mode, the chairman unit can be set in “podium mode”, keeping in active state.

1-2 Vote/Ballot Function

- If the chairman unit is equipped with a graphical LCD, it can conduct a ballot which follows the regulations of Parliament (approve/oppose/abstain), or a questionnaire (1, 2, 3, 4 and 5). The result can be displayed on LCD of all conference units (the beginning and the end of the vote are controlled by the chairman unit).

1-3 Information Display

- The directory and information in multiple languages (Simplified Chinese, Traditional Chinese and English) can be displayed on 256*64 graphical LCD of conference units.

1-4 Auto Video Tracking

- Auto video tracking function can track the speaking delegates in the conference.

1-5 System Self-examination

- Built-in self-examination function can perform self-examinations for the microphone, button, speaker and LED light of every unit.

1-6 Against Radio Frequency Interference of Cell Phones

1-7 Extend and Connect Between Control Units Easily

- A control unit (CU) plus extension unit (EXU) system can control a maximum of 254 conference units.

1-8 Desktop or Embedded Conference Units Can Increase The Users' Convenience and Fulfill The Aesthetic Requirement. The Users Can Choose The Installation Method to Reach Their Diverse Requirements.

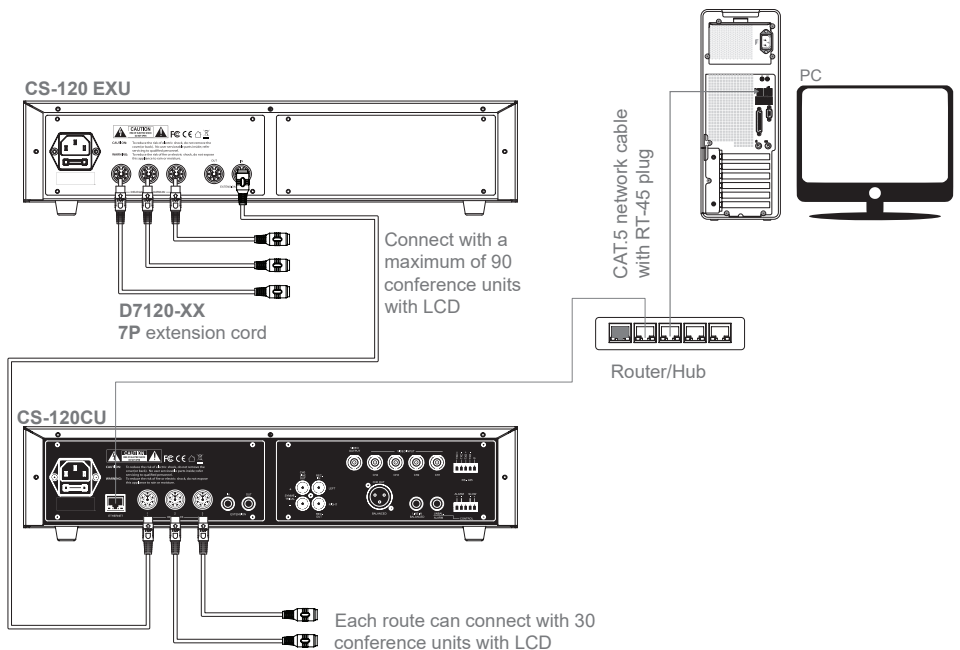

B.External Functions

2-1 Control Unit (CU)

CU is the core of the whole conference system. It provides electric power for all conference units and connects hardware with software. CU can operate basic conference management without personal computer in independent operation mode. A CU can connect with 90 conference units (with LCD).

When a system needs more conference units:

- Add extension unit (EXU). An EXU can provide electric power for 90 conference units. A CU plus many EXUs system can control a maximum of 254 conference units.

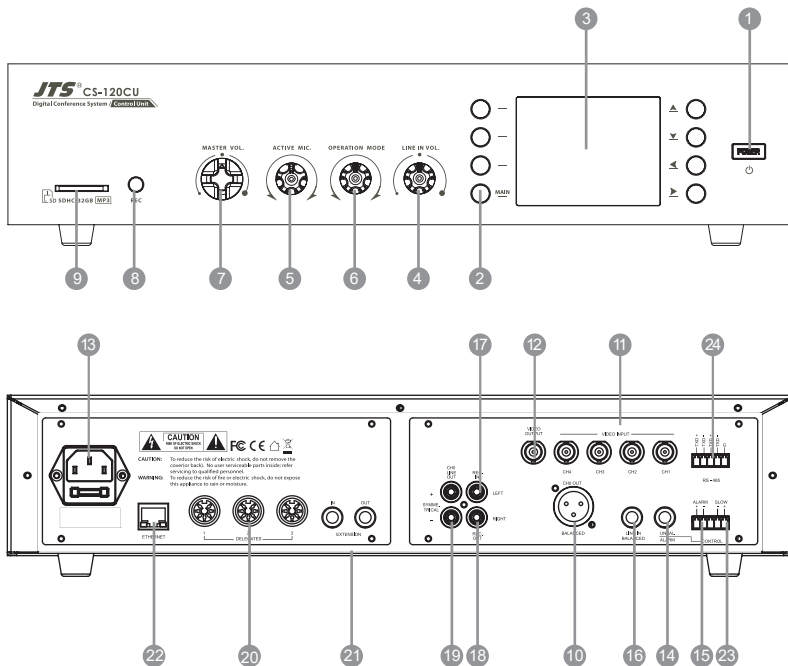

2-1-1 Front Panel

- ① Power switch
- ② Main screen button: Press the button for 3 seconds, and enter the directory of CU LCD; after entering the main screen, press the software button of each function as the display shows to enter subdirectory; operate and set up.
- ③ 320*240 LCD: Display CU's state and directory.
- ④ Line in volume: Adjust Line input signal on back panel.
- ⑤ The maximum number of active microphones knob (1/2/4): Set the number of speaking delegate units in conference.
- ⑥ Operation mode (Open/Override/Voice/Apply): Set the mode of speaking order in conference. The following is function of each mode:
 - “Open” mode: When reaching the maximum number of active microphones (according to the number of speaking units set by (5)), the function of speak button is to register a speaking in order. A maximum of 6 microphones can wait in line for speaking. The gooseneck light of pending microphones will flicker, but the users cannot speak. When one active microphone is turned off, a pending microphone will be on automatically in order.
 - “Override” mode: If reaching the maximum number of delegate units (according to the number of speaking units set by (5)), the first active microphone will be turned off automatically when the speak button of another microphone is pressed, and the last delegate unit whose button is pressed can speak. The system will limit the number of active microphones within the range set by (5).
 - “Voice” mode: The users do not need to press speak button but use voice to activate the microphones. When the user speaks close to the microphone, the microphone will be activated automatically. If the user stops talking for 5 seconds, the microphone will be turned off automatically. The sensitivity can be set as high/medium/low through unit settings of CU.
 - “Apply” mode: Press speak button of a delegate unit to apply for speaking instead of speaking immediately. When the chairman approves the application, the microphone of the delegate unit will be activated; if the chairman rejects the application, the application will be cancelled and the microphone will not be activated.
- ⑦ Master volume: Regulate the speaker volume of all conference units.
- ⑧ Record: Press this button to record the conference.
- ⑨ SD card slot: The storage device of the recordings. When recording a conference, you need to insert formatted SD card (FAT format). The maximum storage capacity of SD card supported by the product is 32 GB.

2-1-2 Back Panel

- ⑩ CH0 line output: 3-pin XLR balanced output which can transmit the voice in conference to other devices in a long distance.
- ⑪ Video input (4 BNC adaptors): There are 4 video inputs and 1 output. Connect with dome cameras for video tracking in conference, or link other analog signals to display videos.
- ⑫ Video output (1 BNC adaptor): There are 4 video inputs and 1 output. Export analog signals to TV wall or projector for video display.
- ⑬ Power plug: AC110V or AC220V input.
- ⑭ Alarm audio input terminal ($\phi 6.3\text{mm}$ jack unbalanced input): Connect to audio output of alarm system to deliver broadcasting alarm message to every conference unit. The message will also be broadcasted by speakers of conference units to inform emergency conditions.
- ⑮ Fire alarm triggering input terminal:

Trigger the alarm: When the alarm triggering input terminal contacts with ground terminal (short circuit), all microphones of conference units will be turned off (including speaking ones and pending ones), and the gooseneck lights will be flickering. All conference units deliver alert sound once, and the speakers of conference units start to broadcast the message delivered by (14) until the alarm stops.

Stop the alarm: When the alarm triggering input terminal does not contact with ground terminal or input high electrical potential ($<+5\text{VDC}$), conference units will return to normal condition.
- ⑯ Line input adaptor ($\phi 6.3\text{mm}$ jack balanced input): Connect external audio with conference audio for remix.
- ⑰ Record input terminal (one RCA): Connect external audio with internal recordings for remix, and the recordings are stored in SD card.
- ⑱ Record output terminal (one RCA): Export recordings. The user can supervise if the recordings are normal, or can export the recordings to other devices.
- ⑲ CH0 line output: RCA terminal with balanced output signal. Export conference audio to other devices or equipment.
- ⑳ Unit connection output terminal (1-3, three output terminals, 7P-DIN plug): Connect with conference units, such as chairman unit/delegate unit; or connect with EXU to increase the number of conference units. Every output terminal can connect with a maximum of 30 conference units with LCD (without extension cords).
- ㉑ Extension slot: For loop connection ($\phi 6.3\text{mm}$ connector IN/OUT).
- ㉒ Ethernet connector: Connect with CU and PC with TCP/IP protocols, for example, location settings of dome cameras for video tracking.

- 23 Slow Control input terminal: Usually connect to Slow Control output terminal of translation system (such as IT-12M or IT-12M4).

Instructions: When the conference system connects to translation system for simultaneous translation, if the translator cannot follow the speed of the speaker, the translator can press SLOW button on translation unit. When the CU receives the SLOW signal, the speaking unit will deliver alert sound (when the alert sound is turned on) and the gooseneck light will turn off (about 1 second) to remind the speaker to slow down.

- 24 Camera control interface (RS-485): Control line to connect with dome cameras.

When connecting with a dome camera, TX+ of CU links to RX+ of the camera, and TX- of CU links to RX- of the camera.

2-2 Extension Unit (EXU)

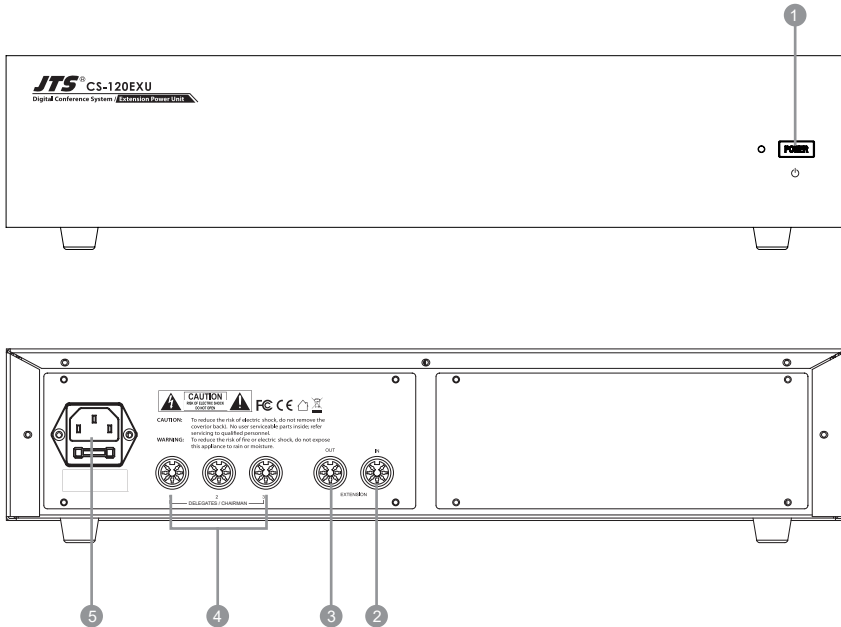

- 1 Power switch and power indicator (red light): When press power button (ON), the machine has built-in ON/OFF interlocking function connecting to CU.
- 2 Extension input terminal (7P-DIN): Connect with CU or the former EXU for signal input of extensive conference units in the system.
- 3 Extension output terminal (7P-DIN): If one EXU is not enough for the number of conference units, you need to connect with another EXU. Connect the output terminal of this EXU with the input terminal of next EXU to increase signal input of conference units.
- 4 Unit connection terminal 7P-DIN (1-3, three output terminals): Connect with conference units, such as chairman unit/delegate unit. Every output terminal can connect with a maximum of 30 conference units with LCD (without extension cords).
- 5 Power adaptor

2-3 CS-120CH Chairman Unit / CS-120DU Delegate Unit

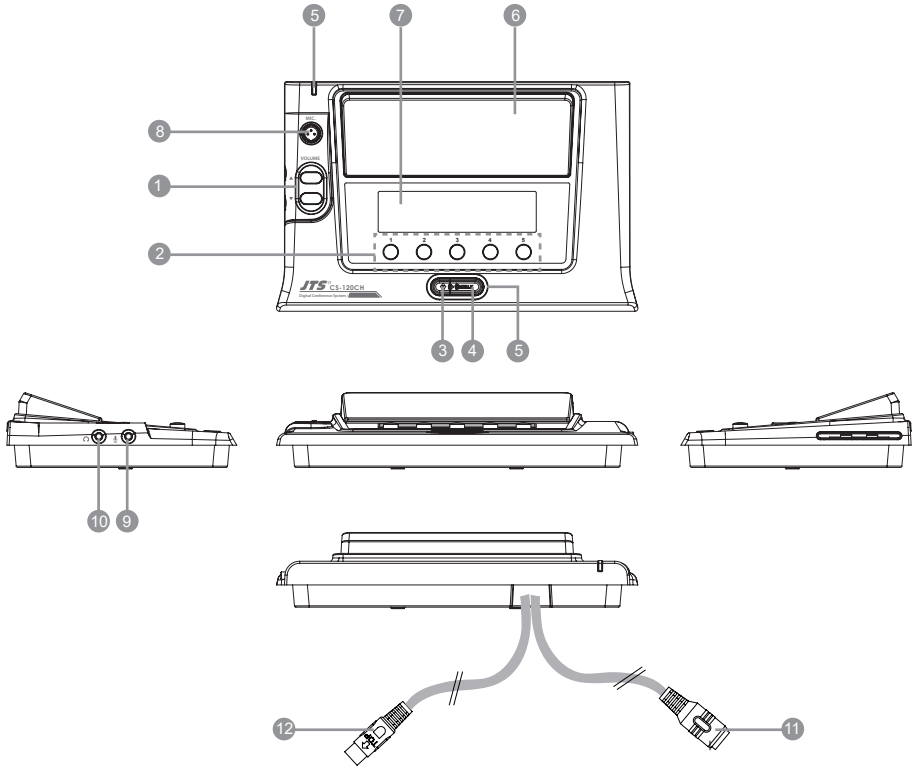

- ① Headphone volume control: The volume increases 1 dB when pressing the upper button; the volume decreases 1 dB when pressing the lower button.
- ② Multi-function buttons and indicators (5 buttons): In different modes, when the indicator flickers, press the correspondent button to operate (the functions are showed in the table below):

Button No. Function	1	2	3	4	5
Regular operation	Vote (chairman unit)	-	Number of speaking	-	Language
Vote	Ballot (chairman unit)	-	Questionnaire (chairman unit)	-	-
Register	Register attendance	-	-	-	-
Ballot	-	Approve	Oppose	Abstain	Enter
Questionnaire	1	2	3	4	5

- ③ Priority button (only equipped on chairman unit): The user can set priority mode in CU. The following is the functions:
- “All mute”: When the chairman presses the priority button, all active microphones of delegate units will become mute temporarily; when the chairman releases the priority button, all microphones return to former state.
 - “All off”: When the chairman presses the priority button, all active microphones of delegate units will be turned off, and the applications of applying (apply mode) or pending (open mode) delegate units will also be cancelled.
 - If the microphone of chairman unit is not activated, press the priority button can also activate the microphone.
 - When alert sound is set as “ON”, press the priority button will produce alert sound.
- ④ Speak button (chairman unit): Turn on/off the microphone and speaking indicator.
- ④ Speak/speak application button (delegate unit): Different functions in different modes, as the following shows:
- “Override” mode: Press the button to turn on/off the microphone and indicator (speaking indicator and gooseneck light).
 - “Open” mode: When the number of active microphones does not reach the maximum, press the button can turn on/off the microphone. When the microphone is on, the speaking indicator and microphone light ring (gooseneck light) will become red. When the number of active microphones reaches the maximum, press this button can apply/cancel speaking application. The speaking indicator and the gooseneck light will become red and flickering. A maximum of 6 delegate units can enter speaking application waiting line.
 - “Voice” mode: When the user is not talking, the speaking indicator (speaking light) of microphone is red light; when the user is talking, the speaking indicator (speaking light) and the light ring (gooseneck light) of the microphone are red. When the microphone is on, the user can press the button to turn off the microphone.
 - “Apply” mode: When the number of active microphones does not reach the maximum limit, press the button to apply/cancel a speaking application. Only one delegate unit can apply in the same time. When the number of active microphones reaches the maximum limit, only one delegate unit can enter speaking application line, but the application message will show on the chairman unit after any active microphone is turned off. And then the chairman will decide to approve or reject the application.
- ⑤ Speaking indicator (speaking light) (red). The following is its conditions:
- When the microphone is on, the indicator is red.
 - In “Apply” mode, the indicator is flickering.
 - In “Voice” mode, the indicator is on.
 - When the priority button of chairman unit is pressed, the indicator is red.

- ⑥ Built-in Hi-Fi speaker: To export the speaking sound in conference. The master volume setting in CU controls the volume of the speaker. When the microphone is on or the user inserts the headphone, the speaker becomes mute to avoid whistles.
- ⑦ 256*64 high brightness graphic LCD: Display directory and messages, and change languages (such as Traditional Chinese and English).
- ⑧ Gooseneck microphone adaptor
- ⑨ Microphone adaptor (φ3.5mm): Connect to external microphone output. When the user inserts a microphone, (8) gooseneck microphone will be off.
- ⑩ Headphone adaptor (φ3.5mm): Connect to external headphone output. When the user inserts headphones, (6) built-in speaker will be off.
- ⑪ 0.6m 7P-DIN standard plug cable (female connector*1): Connect to the next conference unit or terminal connector.
- ⑫ 1.5m 7P-DIN cable standard plug (male connector*1): Connect to the former conference unit, CU or output terminal of EXU.

2-4 Pluggable Gooseneck Microphone

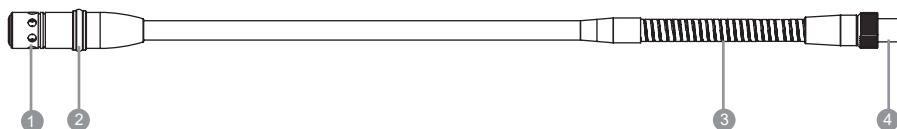

- ① Cardioid condenser microphone
- ② Microphone on/off LED light ring
 - When the microphone is on , the LED light ring will keep on
 - When the user applies for speaking, the LED light ring will be flickering.
- ③ The user can freely adjust the angle and the direction of the gooseneck microphone.
- ④ Adaptor with screw thread. During an adjournment, the gooseneck microphone can be removed for storage.

C. System Connection

3-1 Conference Unit Connection

CS-120 Conference System has simple and effective structure. The system can be installed easily and fast without special training. Special extension cords connect the conference units with other conference units and CU by daisy chain scheme. CS-120CU has 3 export backbone cables (7P-DIN) to connect with conference units. Every conference unit is equipped with a cable with 7P-DIN male connector. Since the distance between conference units are diverse, there are original cable connection and extension cable connection as follows:

● Original cable connection

CS-120 conference units are equipped with a 1.5 m 7-Pin cable with male connector and a 0.6 m 7-Pin cable with female connector. The male cable connector of the first conference unit links to the 7 PIN-DIN output adaptor. The female cable connector behind the first conference unit links to the male connector of the second conference unit, and so on. The female connector of the last conference unit links to the terminal connector.

● Extension cable connection

When the distance between conference unit and CU or other conference units is longer than 2.1 m, the user needs to use extension cable to connect the units. Because of the resistance, the extension cable causes the decrease of voltage. When the cable length is longer, the number of connectable devices of every cable connector will decrease.

The relationship is as the following table:

The distance between CU and the first conference unit (the length of extension cable)	The number of connectable conference units of every connector
10m	30
20m	27
40m	24
80m	21
100m	16

Table 3-1 the relationship between extension cable length and conference units

When extension cable connects CU with the first conference unit, in the meantime, the maximum load current of CU can affect all following units. However, the effect of extension cable between the last two conference units is negligible, because the cable only carries the current of the last unit. For example, in one way without other extension cable, only one 100 m extension cable connects the 29th with the 30th conference unit.

For instance:

Originally, if the number of conference units is less than 90 without extension cable, CS-120CU has 3 7P-DIN adaptors: every adaptor can connect with a maximum of 30 conference units with LCD, and a CU can connect with 90 conference units. However, if the distance between conference units and CU is about 100 m, according to the previous table, every 7P-DIN adaptor can only connect with 16 conference units with LCD, and a CU can only connect with 48 conference units.

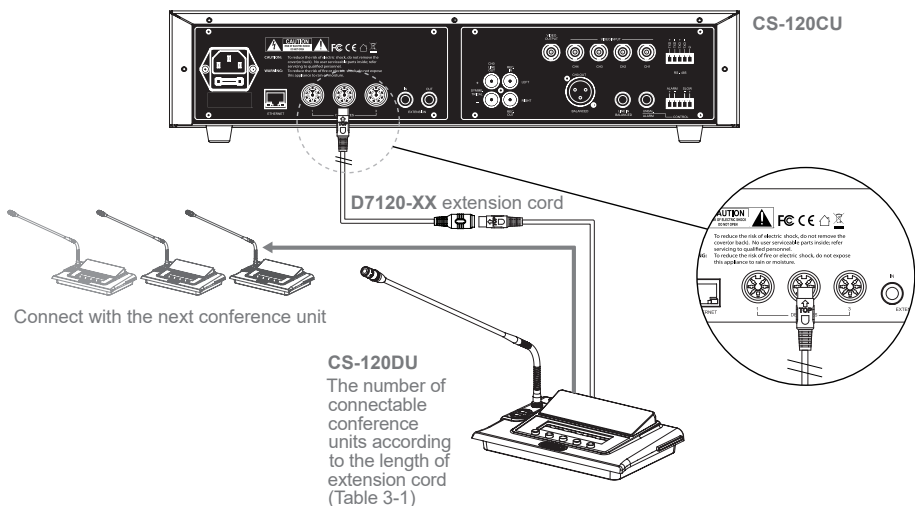
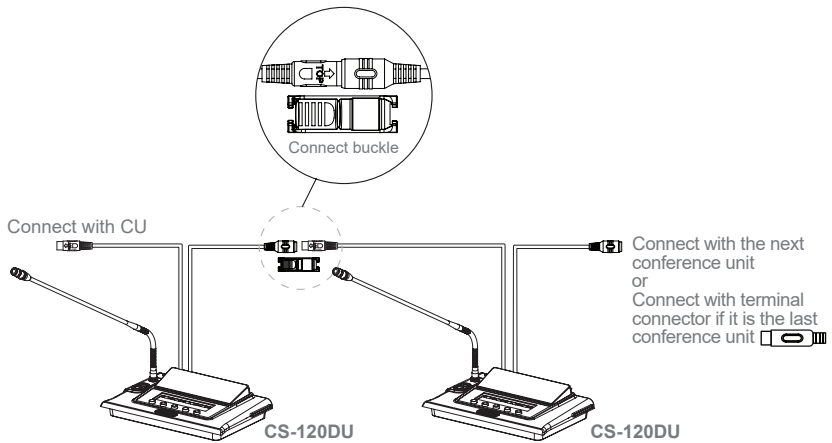

3-2 Connection of Extension Unit (EXU) and Control Unit (CU)

CU is the core of the whole conference system. CU provides power for all conference units. As a result, the number of units connecting with CU is associated with CU's ability to provide and control power. When there are more conference units, or most conference units need long-distance connection, CU needs to connect with EXU to increase the number of conference units in the system. An EXU can provide power for 90 conference units (with LCD). A CU and many EXUs can control a maximum of 254 conference units.

For longer distance between conference units and CU/EXU. One end of the cable is equipped with 7P-DIN male connector, and the other end is equipped with 7P-DIN female connector. Connect the female connector with conference units, and connect the male connector with CU output. Adopting extension cable will decrease the number of connectable conference units. The number of connectable conference units of every 7P-DIN adaptor is showed in Table 3-1.

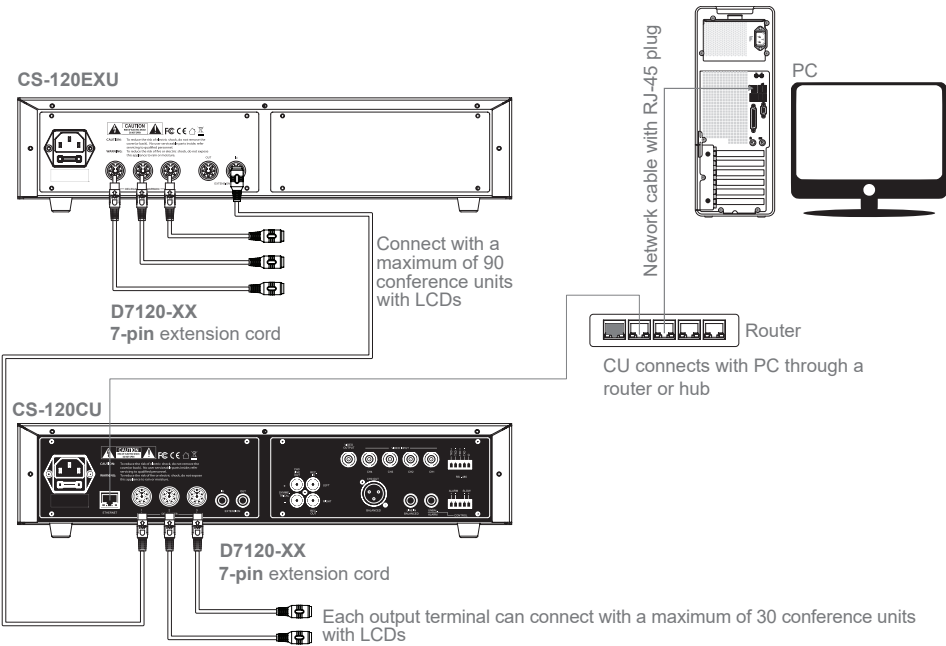

3-3 Peripheral Equipment Connection

CS-120CU has many peripheral equipment adaptors. Audio signal input/output terminals can connect with different peripheral equipment, as the following figure shows.

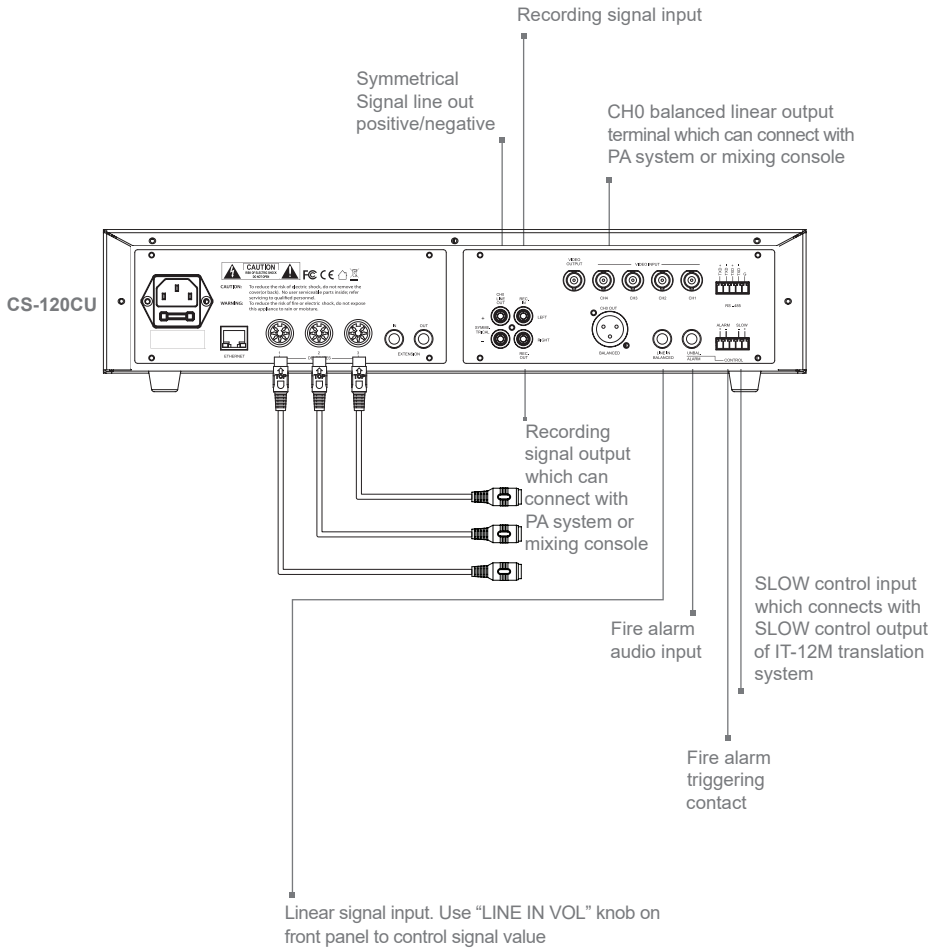

3-4 Video Tracking Equipment Connection

CS-120CU has 4 input and 1 output video switching interface. By using conference planning and video tracking software for CS-120, the user can conduct preset tracking and locating for every conference unit. After setting up the locating, when the user starts to speak with desktop machine, the dome camera will quickly track the location of the speaking conference unit according to the preset locating, and project the speaker's image on the screen in the conference by the video switching interface of CU. Please read the product manual of "video tracking" software for more details.

The following figure is the schematic diagram of video tracking connection:

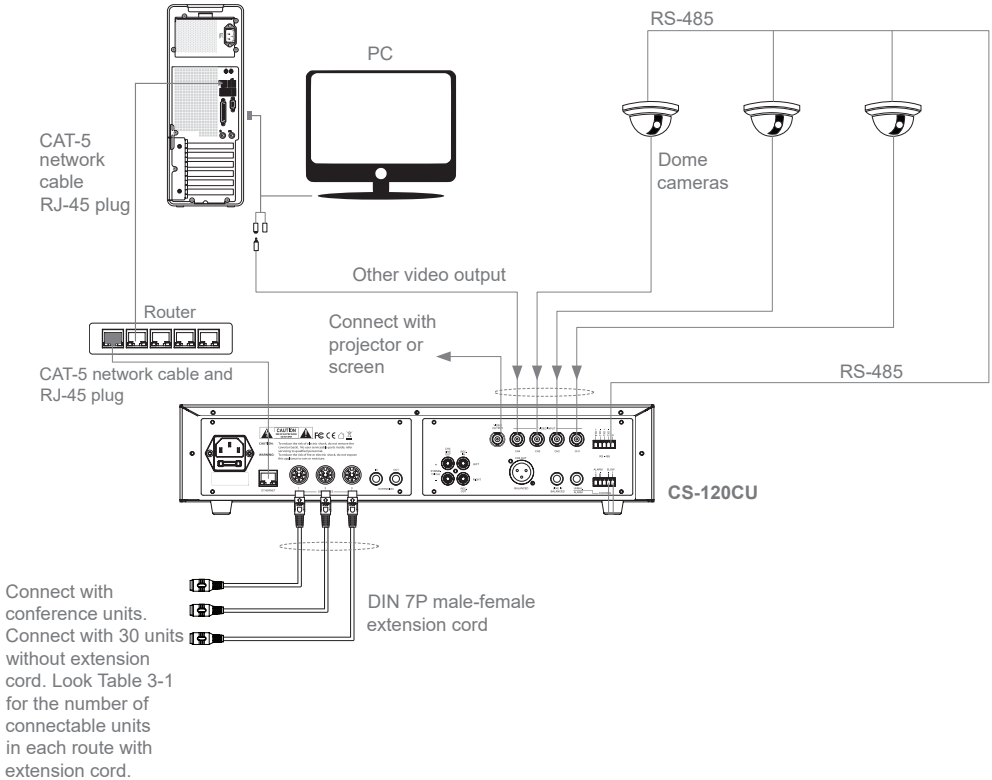

D. System Set-up and Operation

After finishing the installation and connection of conference system, the user should plan thoroughly with operation directory and buttons before the conference. The operation items will show as the following figures on LCD.

4-1 Initialization and Self-examination

After CU has electric power, the system will start initialization and self-examination as the following figures show:

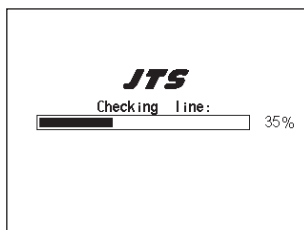
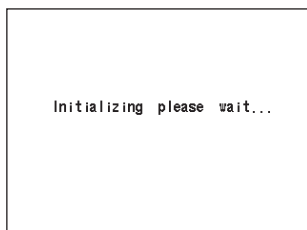

Connect with PC

When CU connects with PC, the front panel will be locked, and all operation directory cannot be accessed, as the right figure shows:

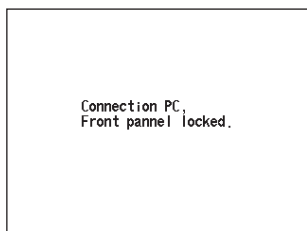

When the application software is operating in computer control mode, the front panel of CU will be locked, and the user cannot control and set the system. Therefore, before controlling and setting CU, please shut down the application software or disconnect CU with PC.

4-2 System Self-examination

As the following figure shows, the items showed on LCD upper part include: “Operation mode”, “Number of active microphones”, “Video tracking” and “Video channel.” The middle part shows the set value and display value of master volume and linear volume. The following explains the functions of each item:

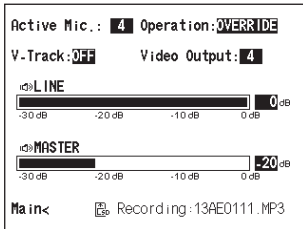

4-2-1 Operation mode

Adjust the operation mode knob of CU can select operation modes of the system, and show the selected mode (Open/Override/Voice/Apply) on LCD. The following is the four modes:

- “Open” mode: When the number of microphones reaches the maximum, speak button can be used to apply for a speaking. A maximum of 6 microphones can register speaking application. When one active microphone is off, the first microphone in the waiting line will be turned on automatically.
- “Override” mode: When the number of microphones reaches the maximum, the first active microphone will be turned off mandatorily by another microphone which just be turned on. The number of microphones does not exceed the set maximum.
- “Voice” mode: Turn on the microphone by voice. When the user talks close to the microphone, the microphone will be on automatically, and be off 5 seconds after the speech finishes. The sensitivity of voice mode can be adjusted through CU.
- “Apply” mode: The user of delegate unit can press speak button to apply for a speaking, and the user of chairman unit can approve or reject the application.

4-2-2 Video tracking

Show the current state (ON or OFF) of video tracking function of CU.

4-2-3 Video channel

CU offers 4 to 1 video channel switching function. When “video tracking” function is “OFF”, the signal of the video tracking channel will switch to video display channel.

4-2-4 Volume control

Volume control knobs on CU front panel—LINE IN VOL control knob and master volume control knob. The volume value will be showed on LCD when adjusting the volume.

4-3 Main Directory

Press the “MAIN” button on the bottom left corner of starting-up complete screen for 3 seconds. After the word “Home” are highlighted, the user can enter the main directory, including 8 items: “Network Address”, “Unit Number”, “Unit Settings”, “Video Settings”, “Language Settings”, “Unit Test”, “Record Settings” and “CU Information”.

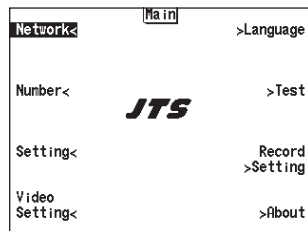
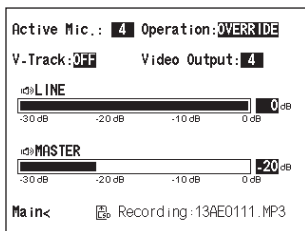

The chosen item will be highlighted (like “Network Address” above).

4-3-1 Network address

“Network Address” includes three items:

- “IP Address”
- “Subnet Mask”
- “Internet Gateway”

When CU connects with PC by local area network, the user needs to access into “Network Address” screen on CU, confirm IP address of CU, and enter the IP address in IP input inner window for connection.

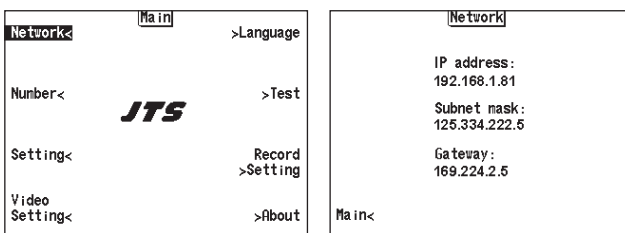

4-3-2 Unit Number

After installing CS-120 series system, all conference units need to finish unit number operation before the first use, or added/substituted conference units need to finish unit number operation for connection. After selecting “Unit Number”, LCD shows two items “Renumber All” and “Expand Number”, as the bottom right figure features.

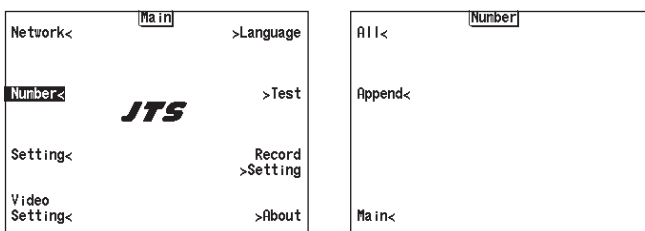

●“Renumber All”

When pressing the “Renumber All” button, it will enter into the process. Press the button beside “Start Numbering” on LCD, and all LEDs of conference units connecting CU system start flickering. After pressing one of “Number” buttons of each conference unit (“Number” buttons are speak button and multi-function button), the LED of the conference unit will be off, and the conference unit will enter into the system order. The system order starts from “1”, and the number of the next conference unit will increase 1.

After finishing numbering, select “Finish Numbering”, and CU will auto-test every connection as well as read number information. After testing all unit connections, CU will update the number of connections in the system.

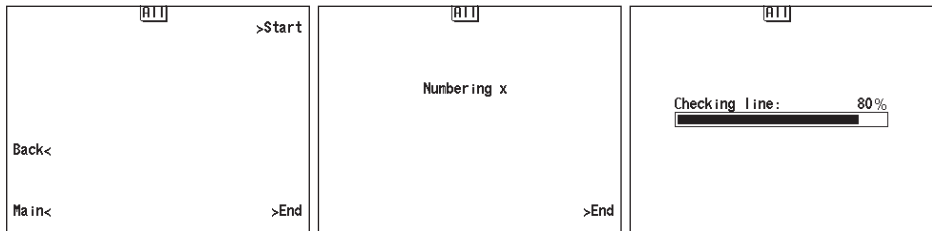

●“Expand Number”

When the user need to increase the number of conference units or replace conference units, the user can connect to the current system directly without restarting CU. Select “Expand Number” on LCD, the system will add from the largest number. Press one of “Number” buttons of all added/substituted conference units (“Number” buttons are speak button and multi-function button), speaking lights of added conference units will start flickering. The user only needs to press “Number” buttons of added or substituted conference units to finish the process without renumbering all units. After finishing numbering, press “Finish Numbering” to complete the process. CU will test the connections of conference units and read number information automatically.

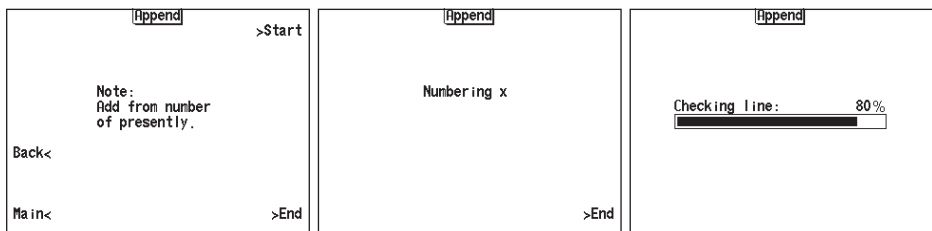

4-3-3 Unit Settings

The directory of “Unit Settings” is used to set operation function of conference units. The included items are:

- “Dais Mode”
- “Priority”
- “Voice Level”
- “Ring”
- “Timing Speak”
- “Panel Lock”

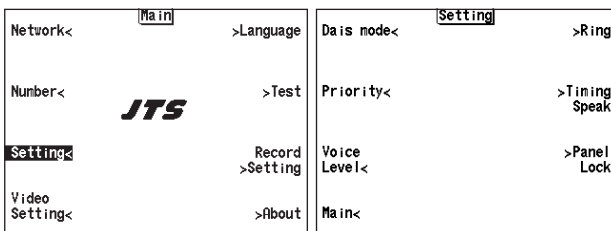

4-3-3-1 “Dais Mode”

In “Open/Override/Apply” mode, chairman units can be set as “Dais Mode”. These chairman units will keep the microphones on until the set state changes.

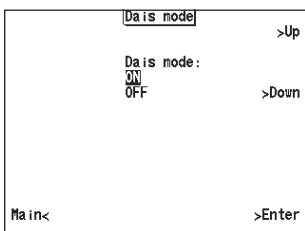

Press Up/Down to choose items.

Press “Enter” button to confirm and return to the main directory.

4-3-3-2 “Priority”

This mode is used to set priority button of chairman unit, including two items as the following shows:

- “All Mute”: When pressing the priority button of chairman unit, all active conference units will be muted; after releasing the priority button of chairman unit, all conference units return to former state.
- “All Off”: When pressing the priority button of chairman unit, all microphones are turned off, and be cancelled speaking applications/waiting line.

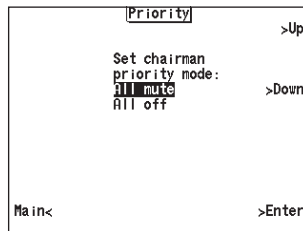

- Press “Up/Down” button to choose “All Off ” or “All Mute”, in order to set the operation method when pressing “Priority” button of chairman unit.
- Press “Enter” button to confirm and return to the parent directory.

4-3-3-3 “Voice Level”

Set the microphone sensitivity in “Voice” mode as “High”, “Medium”, and “Low”. “High” sensitivity means soft or thin voice can turn on the microphone. Relatively, “Low” sensitivity means louder voice can turn on the microphone, but the microphone is less easily affected by outside noises.

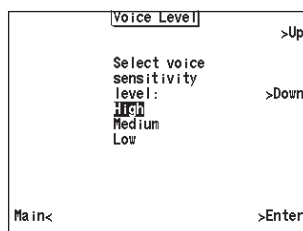

- Press “Up/Down” button to choose “High Sensitivity”, “Medium Sensitivity” and “Low Sensitivity”, in order to set microphone sensitivity in Voice mode.
- Press “Enter” button to confirm and return to the parent directory.

4-3-3-4 “Ring”

Set whether the system will produce alert sound. When conducting unit numbering, system examination, attendance registering, speaking application or application rejected, the speaker will produce alert sound.

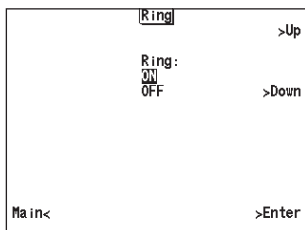

Press Up/Down to choose whether the alert sound is on or off.
Press “Enter” button to confirm and return to the main directory.

4-3-3-5 “Timing Speak”

The system can set speaking time limit of speaking conference units. The time range is 1-255 minutes.

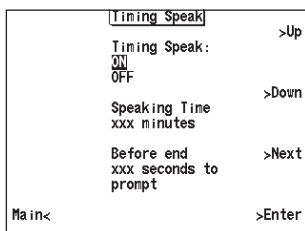

Press Up/Down to choose On or Off.

- “Off”: No time limit for delegate units. Press “Save” button to return to the parent directory.
- “On”: When choosing “On”, LCD will show the settings of speaking time.

And the settings of alert time before the speaking ends. Press “Next” to enter the settings of speaking time; press Up/Down to adjust the time value, and the range is 1-255 minutes. Press “Next”, and the cursor will move to the settings of alert time before the speaking ends; Press Up/Down to adjust the time value, and the range is 2-255 seconds.

Confirm the value, press “Enter”, and save the settings.

4-3-3-6 “ Panel Lock ”

Set CU Panel knobs as "Lock" or "Unlock".

This function to prevent inadvertently change the operating mode of the CU.

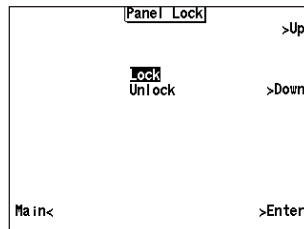

Press Up/Down to select Lock / Unlock knobs of CU.

Press “Enter” to confirm and return to the main directory.

4-3-4 Video Settings

“Video Settings” includes:

- “Camera Protocol”
- “Auto Iris”
- “Video On/Off”
- “Video Channel”

4-3-4-1 “Video Type”

The user can choose several video tracking devices, including PELCO D and PELCO P. The user can choose different devices according to the actual situations.

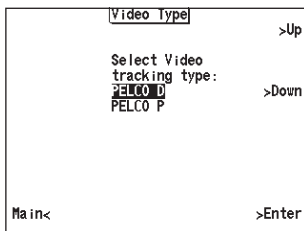

Press Up/Down to choose camera protocol.

Press “Enter” to confirm and return to the main directory.

4-3-4-2 “Auto Iris”

When turning on auto video tracking function, the user can choose whether to turn on auto iris. If the camera iris is manual adjustable, the “Auto Iris” will be “Off”.

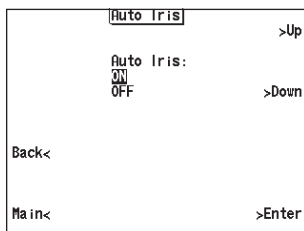

Press Up/Down to choose turning on or off auto iris.

Press “Enter” to confirm and return to the main directory.

4-3-4-3 “Video Track On/Off”

Choose whether to open auto video tracking function or not. When the user chooses “Video On”, and the dome camera is set video tracking and locating, the dome camera will track active conference unit automatically; when the user chooses “Video Off”, the system will not track active conference unit.

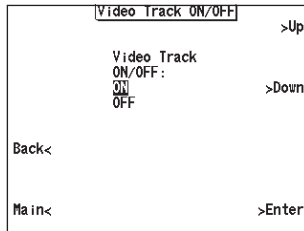

Press Up/Down to select.

Press “Enter” to confirm and return to the main directory.

4-3-4-4 “Video Output”

Select external video output channel after video tracking is off.

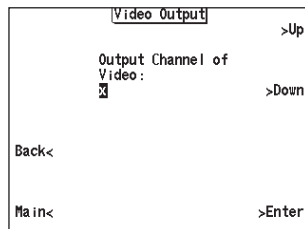

Press Up/Down to select video channel number, from 1 to 4.

Press “Enter” to confirm and return to the main directory.

4-3-5 Language

Set the language featuring on LCD. Available items include Traditional Chinese and English.

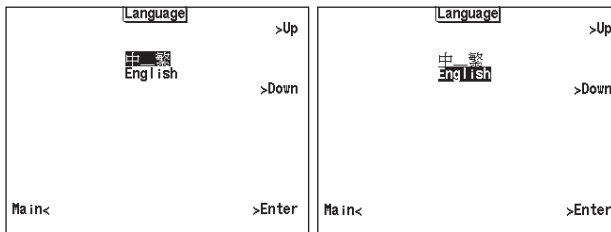

- Press "Up/Down" to select the language featuring on LCD.
- Press "Enter" to confirm and return to the parent directory.

4-3-6 Unit Test (Cannot Access under "Voice" Mode)

The function is used for examining basic functions of conference unit and message display of system connection before a conference, in order to ensure normal function. The items of "Unit Test" include:

- "Microphone"
- "LCD"
- "Keys"
- "Speaker"
- "LED"
- "Mic. Status"

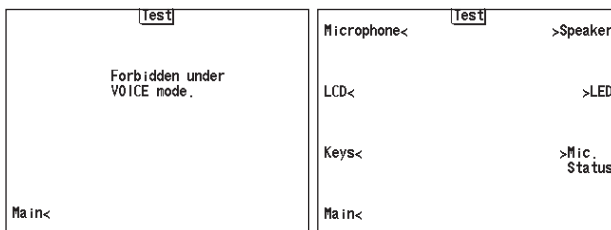

4-3-6-1 “Microphone”

Before a conference, examine if the microphones of conferences units are normal. CU screen will display the currently tested microphone number. In the meantime, the speaking light and the microphone of the conference unit will be turned on. The tester can conduct microphone test of the conference unit.

Note: If no conference unit is connected, the user cannot access into this screen.

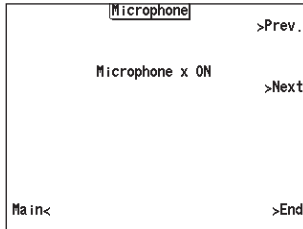

- Press “Previous/Next” button to test all connected conference units.
- After finishing testing all conference units, press “End” to return to the parent directory.

4-3-6-2 “CU LCD Test”

Examine if the graphic LCD display of CU is normal by using “CU LCD Test” of CU. Press “CU LCD Test”, and the screen will display lateral spaced lines; press any button, and the screen will display longitudinally spaced lines; press any button again, and the screen will become all black. The process can examine any dead or abnormal pixels. After finishing the test, press any button to return to the parent directory.

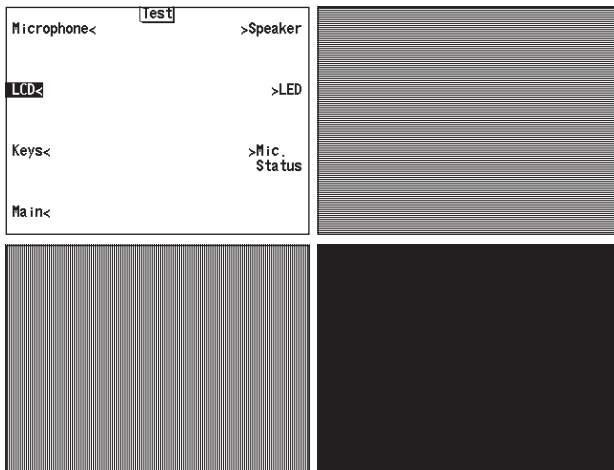

4-3-6-3 "Keys"

Test button before a conference, especially when a conference needs to vote.
Button Test can ensure the accuracy and credibility of vote.

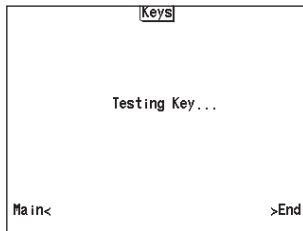

- When accessing into Button Test screen, all connected conference units will enter button test state; the button light of conference units will start flickering.
- The tester presses correspondent button, and the button light will be off; in the meantime, the speaker of the conference unit will produce alert sound. If the button light is not off after pressing the button, or the button is off before pressing the button, it means that the button is abnormal.
- After completing all button test, press "End" to return to the parent directory.

4-3-6-4 "Speaker"

Test if the speaker of conference unit is normal. The screen will show the tested conference unit number, and the speaker of the conference unit will produce alert sound. If no alert sound is produced or the alert sound is abnormal, it means that the speaker does not operate normally. If no conference unit is connected, the user cannot enter into this screen.

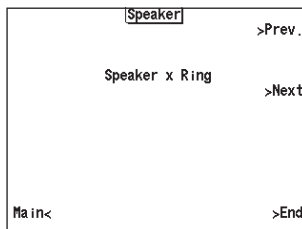

- Press "Previous/Next" to test all conference units
- After testing all speakers of conference units, press "End" to exit the test screen and return to the parent directory.

4-3-6-5 “LED Test”

Enter into LED Test screen, as the following figure shows. LEDs of all connected conference units will start flickering immediately. The tester needs to examine if the LEDs of conference units are off or abnormal.

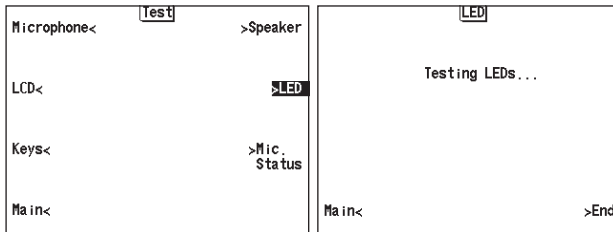

Press “End” to exit LED Test screen.

4-3-6-6 “Mic. Status”

Enter into “Mic. Status” screen. The screen will display the number of all connected conference units, the number of active microphones and the number of speaking applications.

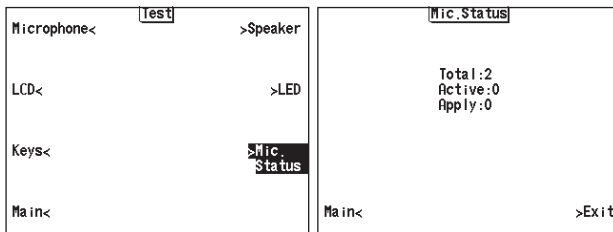

Press “Exit” to return to the previous page.

4-3-7 Record Settings

“Record Settings” includes:

- “Record”
- “Date Settings”
- “Time Settings”

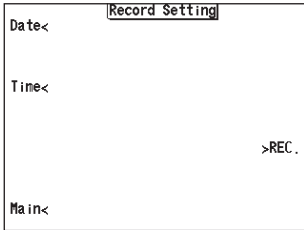

4-3-7-1 “Record”

Enter into “Record” screen, and the screen will feature current date and time of the system. If a SD card is inserted, the bottom will show current remaining memory space of the SD card.

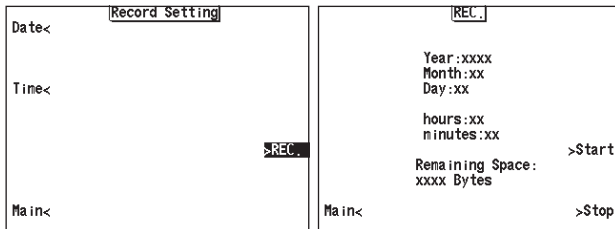

After inserting a SD card, the user can press “Start” for 2 seconds to start recording. The bottom of the screen will show recording filename, and the system will start recording. If the user want to stop recording, press “Stop” for 2 seconds, and the system will stop recording.

The recording filename consists of the date + time when the user starts recording.

The filename has 8 characters, as the following shows:

Character1	Character2	Character3	Character4	Character5	Character6	Character7	Character8
The last two digits of the year		Month	Day	Hour (24-hour system)		Minute	

For example,

The filename of recording which starts at 13:52, Jan 14th 2015 is:

15AE1352.MP3

The encoding rules are as follows:

1. The last two digits of the year: 15 indicates 2015.

2. The code of month:

Month	Jan	Feb	Mar	Apr	May	Jun	Jul	Aug	Sep	Oct	Nov	Dec
Code	A	B	C	D	E	F	G	H	I	J	K	L

3. The code of day:

Day	1	2	3	4	5	6	7	8	9	10	11	12	13	14	15	16
Code	1	2	3	4	5	6	7	8	9	A	B	C	D	E	F	G
Day	17	18	19	20	21	22	23	24	25	26	27	28	29	30	31	
Code	H	I	J	K	L	M	N	O	P	Q	R	S	T	U	V	

4-3-7-2“Date Settings”

Press “Date Settings” to enter into the screen.

Press “Next” to move the highlight square (the highlight square means the item can be changed). Press “Up/Down” to change the digits. When the digits are correct, stop pressing the buttons. Press “Previous” to return to the previous page.

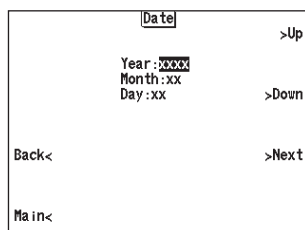

4-3-7-3 “Time Settings”

Press “Time Settings” to enter into the screen.

Press “Next” to move highlight square (the highlight square means the item can be changed). Press “Up/Down” to change the digits. When the digits are correct, stop pressing the buttons. Press “Previous” to return to the previous page.

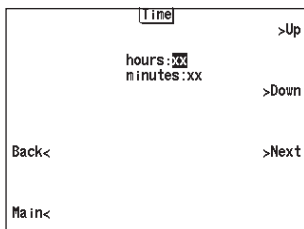

4-3-8 CU Information

CU Information include: software version, company information and product serial number, as the following shows. Press “Home” to return to the main directory.

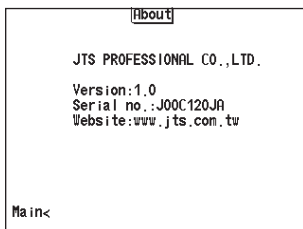

E. Instructions

Before a conference, the user needs to set system configuration of conference units, including: Unit Number and Unit Test. During a conference, the users turn on microphones to speak, apply speaking and vote.

5-1 Unit Number

First, the user needs to ensure correct connections between CU and conference units. When the user uses the system for the first time, or needs to add/replace conference units, the user have to conduct unit number operation for all conference units. This function can be operated by the front panel LCD of CU.

Select "Unit Number", and there are two items, "Renumber All" and "Expand Number", featuring on CU LCD.

- Set up new conference system: The user need to select "Renumber All". After the user presses the button, "Numbering" will be showed on LCD, and LEDs of all connected conference units will flicker. Press the speak button or any function buttons from 1 to 5, the unit number will start from "1". The number of the next conference unit will add 1 to the number of the previous conference unit. Please set conference units in order to avoid missing unit number or amount, otherwise, wrong number may confuse the conference management. After finishing numbering, press "Finish". CU will test the connection of every conference unit automatically, and read related data. CU may restart if necessary.
- When adding or replacing conference units, added or substituted units can connect with the current system directly without restarting CU. Select "Expand Number", and the screen will show "Add from the Largest Number". In the meantime, all button lights of added or substituted conference units will start flickering. Press the speak button or function button 1-5 to expand unit number without restarting the system. Press "Finish" to complete the procedure. CU will test connections and read related data automatically.

5-2 Speak

Before a conference, please select speaking control mode and the maximum of active microphones (no limit number for chairman units). The following is four speaking control modes:

5-2-1 “Open” Mode

- In “Open” mode, if the number of active microphones does not reach the maximum (1/2/4): When the speak button of delegate unit is pressed, the speak button indicator (speaking light) and the microphone light ring (gooseneck light) (red) will be on. The speakers of other conference units whose microphones are off will be on and produce sounds. The built-in speaker in this machine is set mute. When the speak button is pressed again, the microphone of delegate unit will be off, the speaking will be on, and speak button indicator (speaking light) and microphone light ring (gooseneck light) will be off. If no headphone is connected, the built-in speaker will be on; if headphone is connected, the built-in speaker will be off (mute).
- In “Open” mode, if the number of active microphones reaches the maximum (1/2/4): When the speak button of a conference unit is pressed, the speak button indicator (speaking light) and the microphone light ring (gooseneck light) will start flickering. The conference unit enters into speaking waiting line. When the speak button is pressed again, the pending state will be cancelled. If the conference unit is in the waiting line, and one active microphone is off, the first microphone in the waiting line will enter into speaking state automatically.

5-2-2 “Override” Mode

- If the number of microphones does not reach the maximum (1/2/4): when the speak button of a delegate unit is pressed, the speak button indicator (speaking light) and the microphone light ring (gooseneck light) (red) will be on. The speakers of other conference units whose microphones are off will be on and produce sounds. The built-in speaker in this machine is set mute. When the speak button is pressed again, the microphone of delegate unit will be off, the speaking will be on, and the speak button indicator (speaking light) and the microphone light ring (gooseneck light) will be off. If no headphone is connected, the built-in speaker will be on; if headphone is connected, the built-in speaker will be off.
- If the number of microphones reaches the maximum (1/2/4): When the speak button of a delegate unit is pressed, the microphone is on. The first active microphone of delegate units will be off, in order to keep the number of active microphone within the limit.

5-2-3 “Voice” Mode

When the system is set in “Voice” mode, the speaking indicators (speaking lights) of all chairman units and delegate units will be on.

- If the number of microphones does not reach the maximum (1/2/4): When the participant speaks close to the microphone, the microphone will be turned on. The microphone light ring (gooseneck light) will be on, and the built-in speaker will be mute automatically. If the participant does not continue to speak for 5 seconds, the microphone will be turned off automatically, and the built-in speaker will be on. After the microphone is on, the participant can press the speak button to turn off the microphone.
- If the number of microphones reaches the maximum (1/2/4): All other microphones cannot be turned on, unless someone turns off his/her microphone, or other active delegate unit quits speaking state.

5-2-4 “Apply” Mode

- If the number of microphones does not reach the maximum (1/2/4): When the speak button of a delegate unit is pressed, it will produce alert sound (Alert Sound settings in CU needs to be set as “ON”). The microphone light ring (gooseneck light) will flicker. In the meantime, LCD of the chairman unit will show the delegate unit ID number. The chairman can decide to approve or reject the speaking application of the delegate unit. After the application is approved, the microphone light ring (gooseneck light) of the delegate unit will become red, and the delegate unit will enter into speaking state. Only one unit can apply at the same time.
- If the number of microphones reaches the maximum (1/2/4): Only one microphone light ring (gooseneck light) of delegate unit will flicker after the speak button is pressed, but the delegate unit ID number will not be showed on the chairman unit, unless an active microphone is off. When the number of active delegate units is lower than the limit, the chairman unit can deal with the speaking applications.

Note:

All speaking modes and the limit number of active microphones can be set on CU. The number of chairman units is not limited. A maximum of 5 microphones can be turned on in the same system at the same time (the limit number is 4 + chairman units). The dome cameras can track active microphones automatically (combine with video tracking and locating application software). The video of speakers can be displayed on big screen.

5-3 Vote

The chairman unit can hold a vote. When the operator presses Vote button, there are two choices: "Ballot" and "Questionnaire". When the operator decides the voting method, LCDs of all conference units (over function button 1) will show "Register". The conference units pressing "Register" can count votes and attend a vote.

- After entering into a vote, the vote indicator of conference units will start flickering, and the participants can press vote button to vote.
- The participants can change their choices. In "Ballot" mode, only the choice pressed before "Enter" is valid. In "Questionnaire" mode, the participants need to press the same choice twice to make the choice valid; before the second press, the participants can still change their choices.
- The vote result will be displayed on LCD. When any function button 1-5 is pressed, the conference unit will clear the result and return to the boot screen.

5-4 Volume Control

- Regulate the volume of the built-in speakers of delegate units by the master volume control knob.
- When headphones are plugged in a delegate unit, the participant can regulate the headphone volume independently on the left side of the conference unit. In the meantime, the built-in speaker is mute.

5-5 LCD Display of Conference Unit

After initialization of a conference unit, the following figures will be displayed on LCD

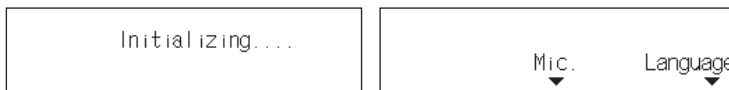

- “Microphone” (“3”): When the participant presses “Microphone”, LCD will show the current information of microphones in the system, including: the number of active microphones (both active chairman units and active delegate units) and the number of applications (the number of applying or pending delegate units).

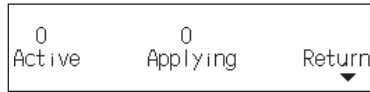

- “Language” (“5”)

Select the language displayed on LCD. As the following figure shows, after entering into the screen, the user can select the language displayed on LCD according to actual needs. The highlighted language will be the displayed language after the user presses “Return”. Press “Return”, and the selected language will be displayed.



5-6 Exclusive Functions of Chairman Unit

The chairman unit not only has all functions of delegate unit but also has the following functions:

5-6-1 “Priority” button: The chairman can use “Priority” button to let delegate units “Mute” or “All Off”, as the following explains:

- If the priority mode of CU is set as “All Mute”: When the chairman presses the priority button, all active delegate microphones will be mute temporarily; after the chairman releases the button, all delegate microphones will return to the former state.
- If the priority mode of CU is set as “All Off”: When the chairman presses the priority button, all active delegate microphones will be off, and the speaking applications and waiting line will be cancelled.

5-6-2 Speaking

- In “Open/Override/Apply” mode, the chairman unit can be set in podium mode. The chairman unit will remain active during the whole conference.

Note: “Podium” mode: In “Open/Override/Apply” mode without connecting PC, the chairman unit can be set in “Podium Mode”, and will keep the microphone active.

5-6-3 Control Delegate Units

- Approve the speaking applications of delegate units

In “Apply” mode, when a delegate unit applies for speaking, the built-in speaker of the chairman unit will produce alert sound (alert sound function of CU is set as “ON”). The chairman can press “1” to approve the application, or can press “5” to reject the application.

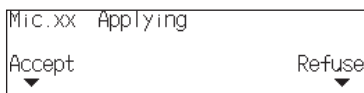

In the meantime, only one delegate can apply for speaking, and the built-in speaker will produce alert sound (when alert sound function of CU is set as “ON”).

5-6-4 Vote

- Start voting procedure: the initial screen of the chairman unit is as the following figure shows:



The chairman presses “Vote” in the initial screen and enters into the following screen. If the user uses “Approve/Oppose/Abstain” to vote, press “1”; if the user uses “Select” to vote, press “3”.

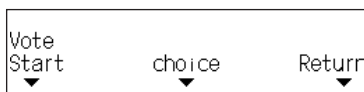

If the user presses “1” to use “Ballot”, all conference units will enter into “Register” state, and all register indicators will start flickering. The delegates can press “1” to register.



After the delegates press “Register”, the screen will show voting options. The chairman can press “Finish” to close the ballot.

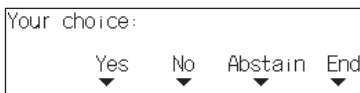

The chairman presses “5” to finish the ballot. All vote indicators of conference units will be off. The system will show the voting result and registration status on LCD, as the following figure shows:

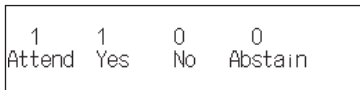

On the other hand, if the chairman presses “3” to use “Select” method for voting. All LCDs of conference units will show the options 1-5. The participants can press the same option twice to complete the vote.



When the chairman presses the same option twice quickly, the voting procedure will be ended. All vote indicators of conference units will be off. The system will show the voting result on LCD, as the following figure shows:

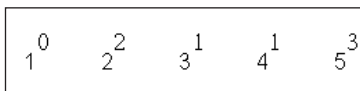

F. Equipment Installation

6-1 Extension Unit (EXU) and Control Unit (CU)

CU and EXU can be fixed on a 19-inch cabinet. CU is equipped with a pair of fixing frames, as (1) in the following figure shows. First, remove the screws on the lateral side of the machine, as (2) shows. Use these screws to attach fixing frames to CU. Finally, use screws to fix CU on the cabinet, as (3) shows.

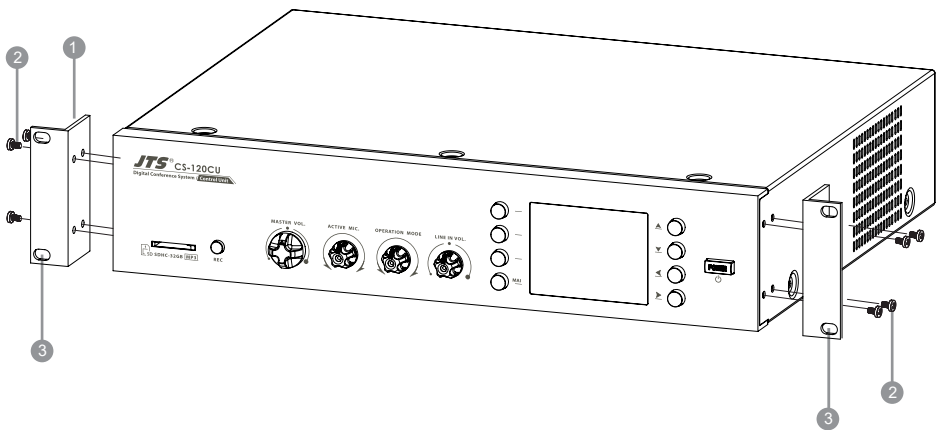

6-2 Conference Unit

The conference unit can be installed on a desktop or embedded.

Embedded installation:

- Cut a hole on the desktop. The size (mm) is as the following figure shows;
- According to the following figure, on the bottom of the hole, drill two $\phi 4$ mm screw holes. The distance between the centers of the screw holes is 80mm;
- Adjust the two cable outlets behind the conference unit according to the actual situation, in order to ensure availability of further installation;
- Put the conference unit into the hole on the desktop, and fix it from the bottom with screws. Choose appropriate screw length according to the desk thickness.

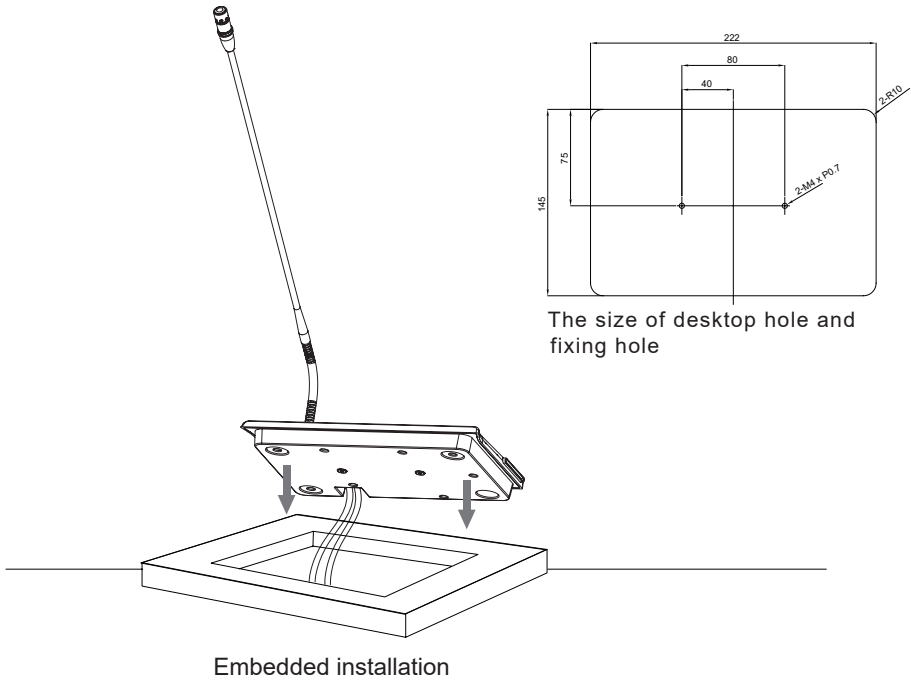

6-3 Electric Cable Connection, 7PIN Plug and Outlet

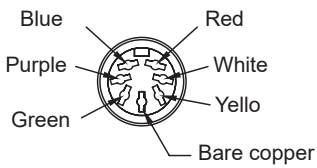

Female connector

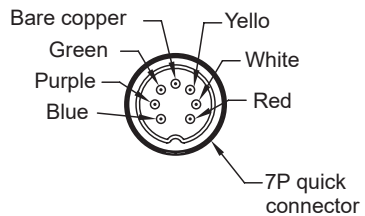

Male connector

6-4 Audio Connection of CS-120 Series Economic Conference System

The connection of signal line plays an important role in long-distance audio transmission. Noises will occur in improper connections. The following introduces three common connection methods for examples of connecting peripheral equipment:

6-4-1 Connection of Unbalanced-to-Balanced Transmission

For example, the audio signals exported by mixer of external wire and wireless microphones, as RCA signals, are transmitted from unbalanced mixer output into balanced input "LINE IN" ($\phi 6.4\text{mm}$ port) of CS-120CU.

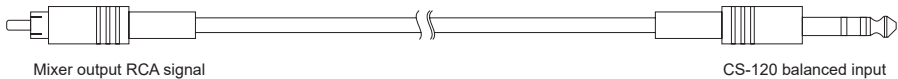

Caution: This kind of connection is not suitable for balanced-to-unbalanced transmission, or the signal source of balanced output may be damaged.

6-4-2 Connection of Balanced-to-Balanced Transmission

For example, the audio signals exported by mixer of external wire and wireless microphones are transmitted from balanced mixer output into balanced input "LINE IN" ($\phi 6.4\text{mm}$ port) of CS-120CU.

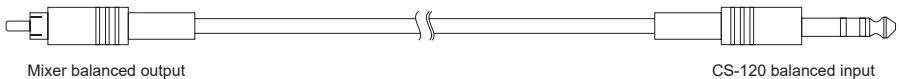

6-4-3 Connection of Unbalanced-to-Balanced Transmission

For example, "REC OUT" (unbalanced output) of CS-120CU are connected with XLR port (balanced input) of PA system or recording input.

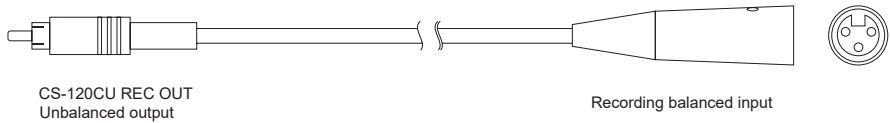

Note: This kind of connection is not suitable for balanced-to-unbalanced transmission, or the signal source of balanced output may be damaged.

6-5 Other Accessories

Some special accessories for connections of conference system, including:

D7120-10/D7120-20 extension cord

- Apply for extensive connection distance between CU and conference units
- standard connector (including male connector and female connector)
- 10m, 20m and 100m are available
- Connect buckle: Ensure reliable connection



D7120MM-1/D7120MM-3 extension cord

- Apply for connection between CU and EXU
- DIN 7P standard connector (male connectors on both ends)
- Length : 1m /3m
- Connect buckle: Ensure reliable connection

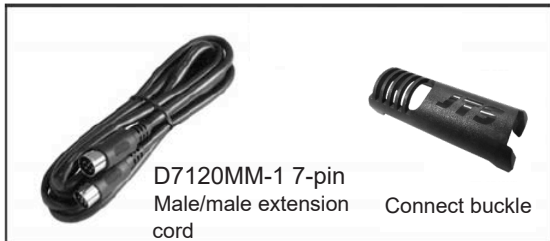

G. Operating Environment and Maintenance

Proper operating environment and maintenance can extend the life of equipment efficiently. Please read the contents carefully for good maintenance.

7-1 Public Environment

- In order to ensure the operation of the system in public area, including connections of extension cables, the system needs to be in a clean environment without interrupting the users.
- It is strongly suggested that the connectors and cables used in public area should be covered and can withstand treading, especially the beginning, not the end, of trunk lines of the chairman units.
- Considering the direction of microphones, the microphones should be adjusted to have a proper distance with the speakers, in order to achieve the best volume and clarity.

7-2 Technical Room (Machine Room)

- The machine room for CS-120 CU should have the following features:
- Dust-free environment.
- Good ventilation.
- Sufficient light which does not interfere the normal operation of the users in the technical room and the system.
- Do not place anything on the top of CU. These things may fall into or cover the vents and hinder the cooling of internal electronic components. The fallen things may cause fire and electric shock.
- No rain or moisture, in order to avoid electric shock or permanent damage of the system.
- Do not remove the cover of CU to avoid electric shock. Only qualified technician can remove the cover. If you need any repair or maintenance service, please contact with JTS regional branches.
- The device is only for indoor use. Do not expose to the sunlight.
Warning: If the electric cord is damaged, please replace it immediately to avoid the risk of fire or electric shock!

7-3 Control Room

- When applying PC system, the operator needs a room for operating the computer and managing conference procedure. The room should be equipped with a microphone, so the operator can remind the participants to conduct related operation, such as voting and registration, through public broadcasting system.

7-4 Ventilation

- Keep good ventilation: Provide vents on the top of CU. Place CU on hard horizontal ground for proper ventilation.

7-5 Exterior Cleaning

- Do not use alcohol, ammonia or petroleum-based fluid or corrosive detergent to clean the equipment. Remove the connection with the first conference unit, and use soft cloth with some mild soap water to clean the exterior. Keep dry is very important.

7-6 Storage

- If the equipment is not used for a long time, disconnect all electric power. Store the equipment in a dust-free and dry environment with good ventilation.

H. Technical Specifications

8-1 System Specifications

Performance

Compliance with the international standards of IEC60914 Conference System

Environmental conditions

Temperature range: ● Transfer/Storage temperature: -40°C ~ +70°C

● Operating temperature: 0°C ~ +45°C

Maximum relative humidity: <95% (no condensation)

Safety standards: Compliance with EN 60065 standards

EMC radiation standards: Compliance with EN61000-6-3 and EN55022

EMC anti-interference: Compliance with EN 61000-4-3

EMC certification: CE

Electrostatic discharge immunity: Compliance with EN61000-4-2

Power harmonic: Compliance with EN61000-3-2

Surge resistance: Compliance with EN61000-4-5

EFT test: Compliance with EN61000-4-4

Transient power measurements: Compliance with EN61000-4-11

8-2 Control Unit (CU)

Equipment dimensions

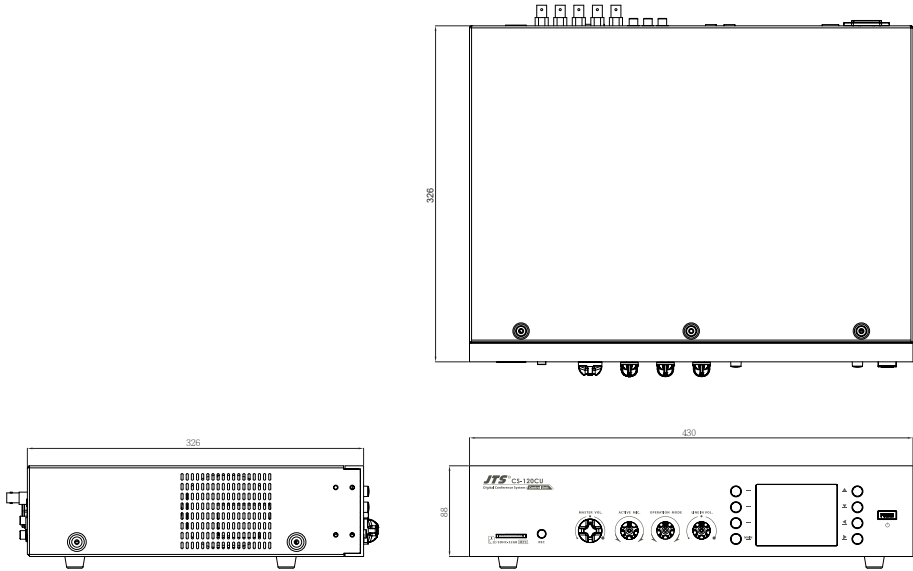

Technical details

Model number	CS-120CU
Supply voltage	AC110Vor AC220V (default settings)
Number of connectable conference units	≤254
Frequency response	40-16000Hz
Signal-to-noise ratio	>80dBA
Dynamic range	>85dB
Audio crosstalk	>70dB
Total harmonic distortion	<0.05% Original input: 6.3 mm balanced Signal strength: 0.775 V
Audio inputs	Recording input: RCA type*1 Original output: RCA*2 balanced, XLR*1 balanced
Audio outputs	Recording output: RCA type*1
SD card slot	Support 32GB SD card in FAT format
LAN interface	RJ45 , or PC control
Conference unit connector	DIN7P
Maximum power consumption	200W

8-3 Conference Unit

Equipment dimensions

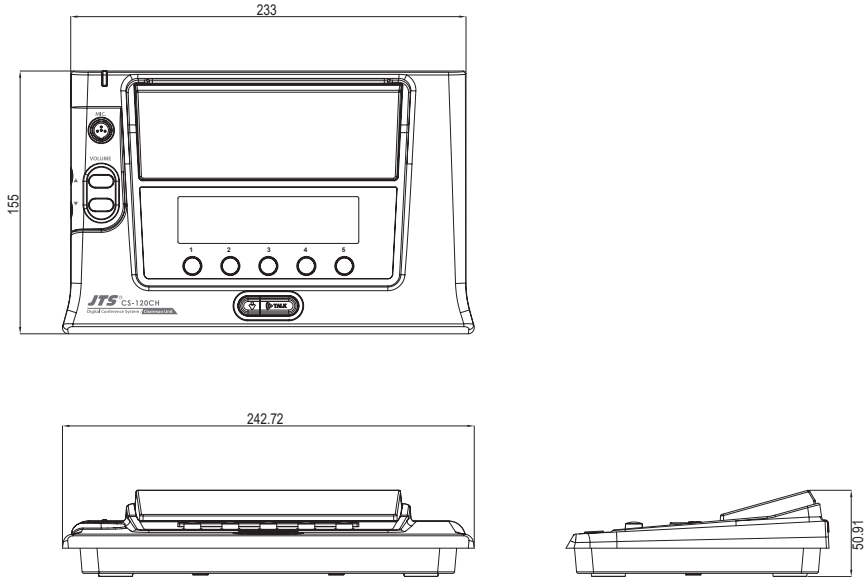

Technical details

Model number	CS-120CH or CS-120DU
Frequency response	40-16000Hz
Headphone load impedance	> 16Ω
Headphone output signal strength	100mV
Maximum power consumption	1.68W
Connecting interface	DIN7P with buckle

Microphone

Model	Unidirectional condenser microphone
Input sensitivity	-46dBV
Frequency response	80-16000Hz
Input impedance	2KΩ

