

# M

**MAX2**  
**Manual 1.2 en**

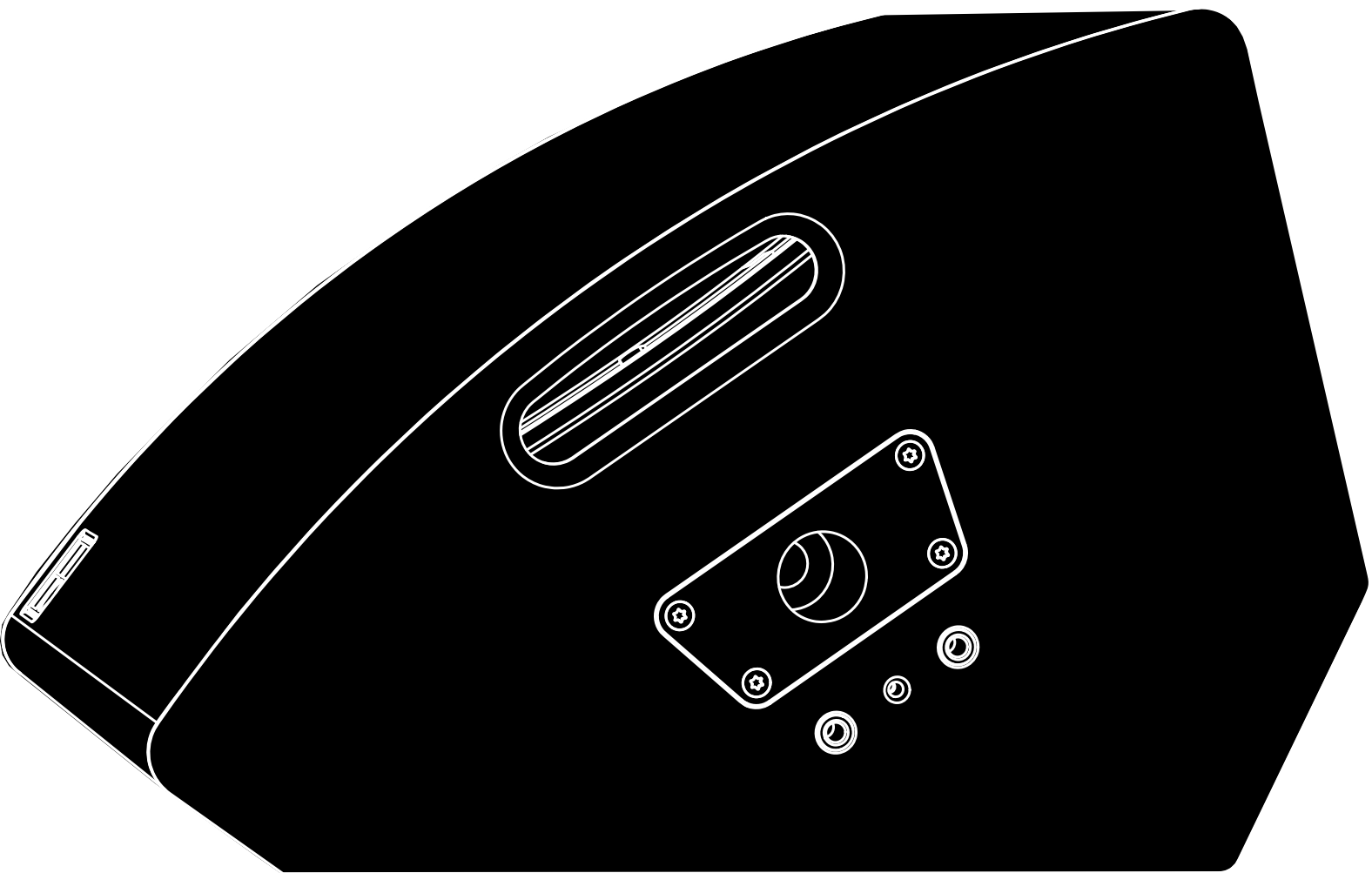

## **General information**

MAX2 Manual

Version: 1.2 en, 03/2016, D2987.EN .01

Copyright © 2016 by d&b audiotechnik GmbH; all rights reserved.

**Keep this manual with the product or in a safe place so that it is available for future reference.**

When reselling this product, hand over this manual to the new owner.

If you supply d&b products, please draw the attention of your customers to this manual. Enclose the relevant manuals with the systems. If you require additional manuals for this purpose, you can order them from d&b.

d&b audiotechnik GmbH  
Eugen-Adolff-Strasse 134, D-71522 Backnang, Germany  
T +49-7191-9669-0, F +49-7191-95 00 00  
docadmin@dbaudio.com, www.dbaudio.com

<b>1. Safety precautions</b> .....	<b>4</b>
1.1. Information regarding the use of loudspeakers.....	4
<b>2. MAX2 loudspeaker</b> .....	<b>5</b>
2.1. Product description.....	5
2.2. Connections.....	5
2.3. Operation.....	6
2.3.1. Controller settings.....	6
2.4. Dispersion characteristics.....	7
2.5. Technical specifications.....	8
<b>3. Manufacturer's declarations</b> .....	<b>9</b>
3.1. EU conformity of loudspeakers (CE symbol).....	9
3.1.1. WEEE Declaration (Disposal).....	9

## 1.1. Information regarding the use of loudspeakers

### Potential risk of personal injury

Never stand in the immediate vicinity of loudspeakers driven at a high level. Professional loudspeaker systems are capable of causing a sound pressure level detrimental to human health. Seemingly non-critical sound levels (from approx. 95 dB SPL) can cause hearing damage if people are exposed to it over a long period.

In order to prevent accidents when deploying loudspeakers on the ground or when flown, please take note of the following:

- When setting up the loudspeakers or loudspeaker stands, make sure they are standing on a firm surface. If you place several systems on top of one another, use straps to secure them against movement.
- Only use accessories which have been tested and approved by d&b for assembly and mobile deployment. Pay attention to the correct application and maximum load capacity of the accessories as detailed in our specific "Mounting instructions" or in our "Flying system and Rigging manuals".
- Ensure that all additional hardware, fixings and fasteners used for installation or mobile deployment are of an appropriate size and load safety factor. Pay attention to the manufacturers' instructions and to the relevant safety guidelines.
- Regularly check the loudspeaker housings and accessories for visible signs of wear and tear, and replace them when necessary.
- Regularly check all load bearing bolts in the mounting devices.

### Potential risk of material damage

Loudspeakers produce a static magnetic field even if they are not connected or are not in use. Therefore make sure when erecting and transporting loudspeakers that they are nowhere near equipment and objects which may be impaired or damaged by an external magnetic field. Generally speaking, a distance of 0.5 m (1.5 ft) from magnetic data carriers (floppy disks, audio and video tapes, bank cards, etc.) is sufficient; a distance of more than 1 m (3 ft) may be necessary with computer and video monitors.

## 2. MAX2 loudspeaker

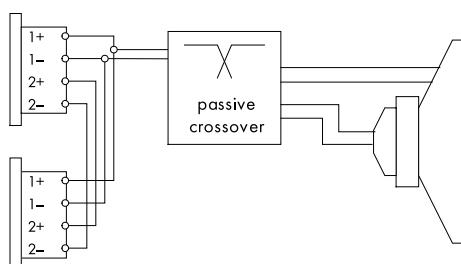
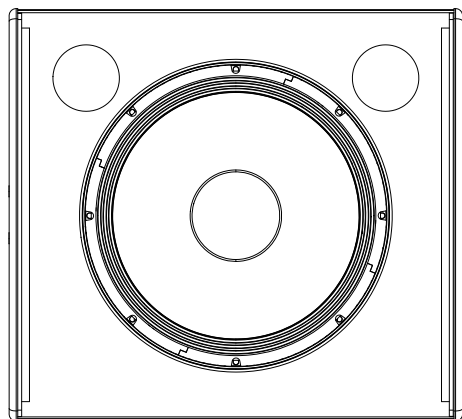

Connector wiring

### 2.1. Product description

The MAX2 is a 2-way stage monitor employing a 15"/1.4" coaxial driver combination with a passive crossover. The driver design allows the use of a compact, low height cabinet.

Coaxially mounting the 1.4" HF compression driver and the 15" LF driver using a single magnet assembly creates a very compact driver with 75° constant directivity HF dispersion.

With a frequency response extending from 55 Hz to 20 kHz, the MAX2 can be used individually as a full range system, or it can be supplemented by different d&b subwoofer systems such as the Y-SUB, V-SUB or B6-SUB.

The cabinet is constructed from marine plywood and has an impact resistant paint finish. The front of the loudspeaker cabinet is protected by a rigid metal grill in front of an acoustically transparent foam. Each side panel incorporates a handle while four M10 threaded inserts allow connection to different rigging devices and brackets. A pole mount is incorporated in one side panel to accept a loudspeaker stand. Two runners recessed in the bottom panel prevent cabinet movement and protect the bottom panel against scratching.

### 2.2. Connections

The cabinet is fitted with NLT4 F/M connectors. All four pins of both connectors are wired in parallel. The cabinet uses the pin assignments 1+/1-. Pins 2+/2- are designated to active subwoofers. Using the male connector as the input, the female connector allows for direct connection to a second cabinet.

The cabinet can be supplied with NL4 or EP5 connectors as an option.

Pin equivalents of the connector options are listed in the table below.

NLT4 F/M NL4	1+	1-	2+	2-	n.a.
EP5	1	2	3	4	5

## 2.3. Operation

### NOTICE!

Only operate d&b loudspeakers with a correctly configured d&b amplifier, otherwise there is a risk of damaging the loudspeaker components.

#### Applicable d&b amplifiers:

D80/D20/D12/D6/10D/30D.

As an alternative, the MAX2 can be driven by other high quality linear power amplifiers, providing their output power does not exceed 800 W (peak) into 8 ohms and an additional subsonic filter is used (25 Hz with 12 dB/octave minimum). Otherwise there is a risk of damaging the loudspeaker components.

Application	Setup	Cabinets per channel
MAX2	MAX2	2

For applicable d&b amplifiers, the controller setup is available in Dual Channel and Mix TOP/SUB mode.

MAX2 cabinets can also be operated using the LINEAR setup of applicable d&b amplifiers. However, the MAX2 setup provides low end equalization and limiter settings specially tuned for MAX2 cabinets used as stage monitors thus providing improved performance and headroom.

### 2.3.1. Controller settings

For acoustic adjustment the functions CUT, HFA and CPL can be selected.

#### CUT circuit

Set to CUT, a high pass filter with a 130 Hz cut off frequency is inserted in the controller signal path. The MAX2 is now configured for use with actively driven d&b subwoofers.

#### HFA circuit

In HFA mode (High Frequency Attenuation), the HF response of the system is rolled off. HFA provides a natural, balanced frequency response when a unit is placed close to listeners in near field or delay use.

High Frequency Attenuation begins gradually at 1 kHz, dropping by approximately 3 dB at 10 kHz. This roll off mimics the decline in frequency response experienced when listening to a system from a distance in a typically reverberant room or auditorium.

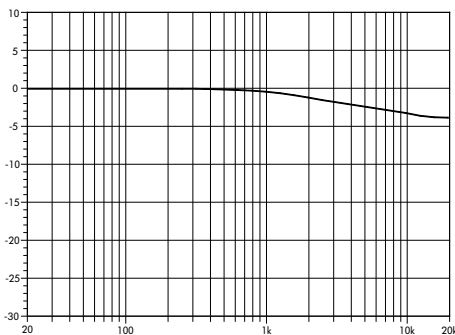

Frequency response correction of HFA circuit

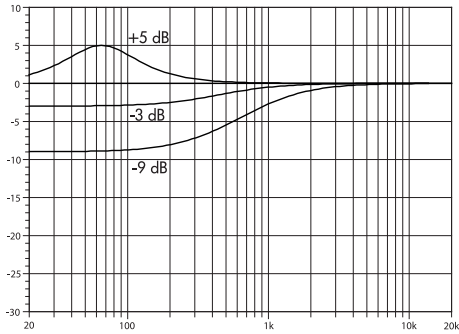

Frequency response correction of CPL circuit

### CPL circuit

The CPL (Coupling) circuit compensates for coupling effects between the cabinet and close boundary surfaces or when the cabinet is used as a stage monitor. CPL begins gradually around 1 kHz, with the maximum attenuation below 400 Hz. To achieve a balanced frequency response, the CPL circuit can be set to dB attenuation values between 0 and -9.

Positive CPL values create an adjustable low frequency boost (0 to +5 dB) and can be set when the system is used in full range mode without subwoofers.

### 2.4. Dispersion characteristics

Due to the conical coverage pattern of the coaxial driver design, the horizontal and vertical dispersion characteristics of the MAX2 are largely identical (slight differences which occur are attributable to the cabinet shape). The diagram below shows dispersion angle versus frequency plotted using lines of equal sound pressure (isobars) at -6 dB and -12 dB. The nominal 75° dispersion angle is maintained from 1 to 16 kHz.

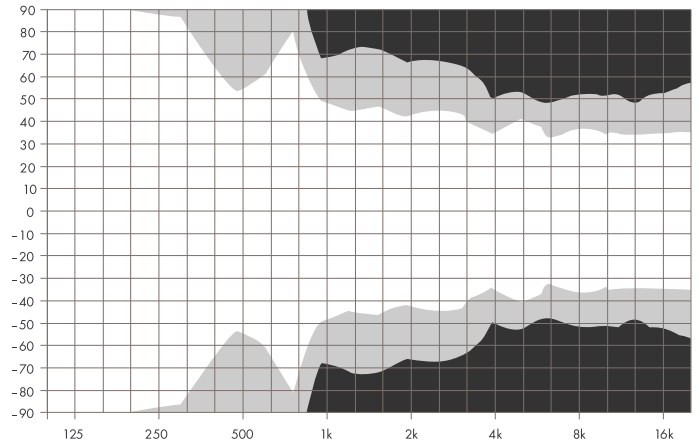

Isobar diagram

## 2.5. Technical specifications

### MAX2 system data

Frequency response (-5 dB standard) .....	55 Hz - 20 kHz
Frequency response (-5 dB CUT mode) .....	90 Hz - 20 kHz
Max. sound pressure (1 m, free field) .....	
with D6/10D .....	131 dB
with D80/D20/D12/30D .....	135 dB
.....(SPLmax peak, pink noise test signal with crest factor of 4)	

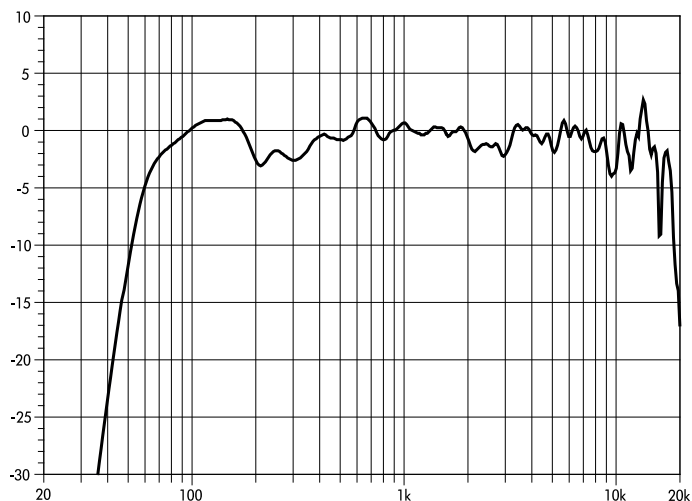

MAX2 frequency response (MAX2 setup, floor coupling, standard)

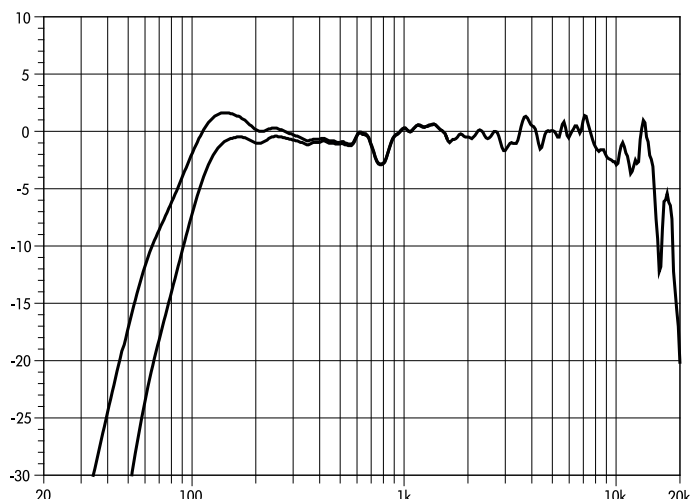

MAX2 frequency response (linear setup, free field), standard and CUT modes

### MAX2 loudspeaker

Nominal impedance .....	8 ohms
Power handling capacity (RMS/peak 10 ms) .....	250/1600 W
Nominal dispersion angle (conical) .....	75°
Components .....	15" LF driver with ferrite magnet
.....	1.4" exit compression driver
.....	Passive crossover network
Connections .....	NLT4 F/M
.....	optional 2 x NL4 or EP5
Pin assignment .....	NLT4 F/M and NL4: 1+ / 1-
.....	EP5: 1: + / 2: -
Weight .....	23 kg (50 lb)

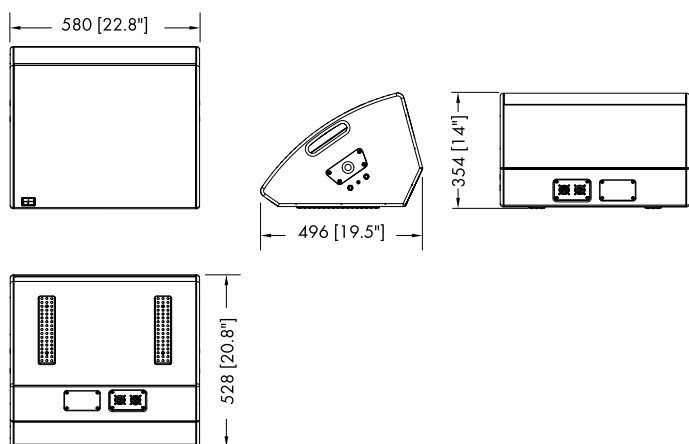

MAX2 cabinet dimensions in mm [inch]





### 3.1. EU conformity of loudspeakers (CE symbol)

This declaration applies to:

#### **d&b MAX2 loudspeaker, Z1120**

manufactured by d&b audiotechnik GmbH.

All production versions of these types are included, provided they correspond to the original technical version and have not been subject to any later design or electromechanical modifications.

We herewith declare that said products are in conformity with the provisions of the respective EC directives including all applicable amendments.

A detailed declaration is available on request and can be ordered from d&b or downloaded from the d&b website at [www.dbaudio.com](http://www.dbaudio.com).

#### **3.1.1. WEEE Declaration (Disposal)**

Electrical and electronic equipment must be disposed of separately from normal waste at the end of its operational lifetime.

Please dispose of this product according to the respective national regulations or contractual agreements. If there are any further questions concerning the disposal of this product, please contact d&b audiotechnik.

